

Apartment Typology Booklet

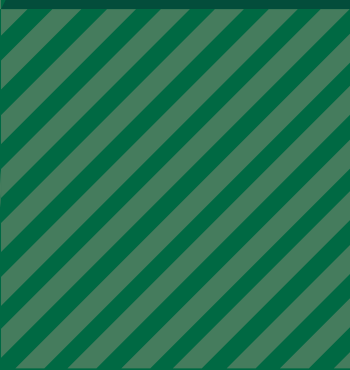

Apartment Typology Booklet

Revision	Date	Description	Prepared by	Reviewed by
Draft 01	06.07.23	Draft Issue	BM	RF
00	24.08.23	First Issue	BM	RF

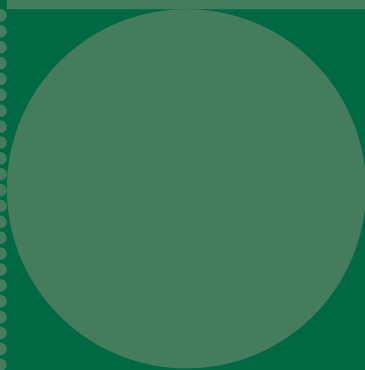
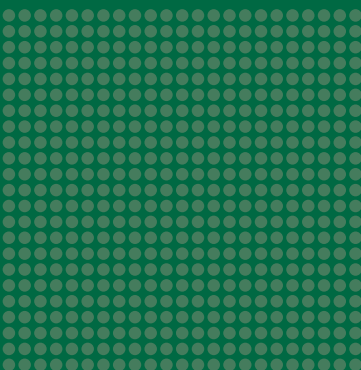
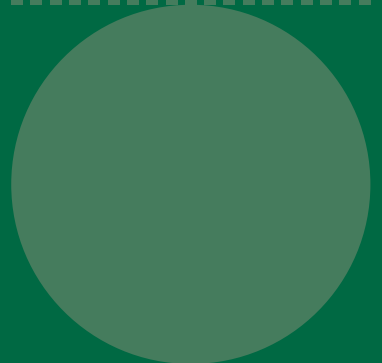
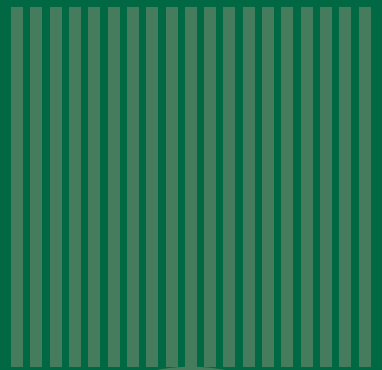

Introduction

0.1	Purpose of Guide	1
0.2	Structure of Guide	3
0.3	LDA Documents	5
0.4	Policy Requirements & Compliance	6

Section One Apartment Design

1.1	Design Principles	9
1.2	Minimum Requirements	13
1.3	Typical Apartment Layouts	25

Section Two Building Design

2.1	Building Layout	35
2.2	Building Form	43
2.3	Building Efficiency	45
2.4	Worked Example	47
2.5	Communal Areas	49
2.6	Communal Storage	51

Section Three Technical Considerations

3.1	Architecture	57
3.2	Structure	61
3.3	M&E	62

Section Four Outline Specification

4.1	Apartments	65
4.2	Communal Areas	71

Section Five Appendix

5.1	Universal Design Apartment Layouts	77
5.2	Non-sprinklered Apartment Layouts	87

Purpose of Guide

The Land Development Agency's purpose is to maximise the supply of affordable and social homes on public land in a financially sustainable manner, supporting the creation of thriving communities and delivering ongoing positive social impact. We aim to design a new generation of homes with a pragmatism and intelligence that ensures that these great new homes can be delivered in a way that achieves maximum value for money.

The purpose of this guide is to facilitate the efficient delivery of affordable homes. The importance of a well-designed apartment layouts, that prioritise the needs of the resident cannot be underestimated. Compliance with the various housing standards, daylight requirements, building regulation and efficiency requirements whilst important should not inhibit the design of functional and usable homes.

The LDA aims to intelligently utilise standardisation in design and construction to improve quality, reduce cost, increase certainty, and deliver consistency across LDA homes. This means all future LDA residents can expect the same level of quality and services across all LDA developments. With a focus on well-designed apartment layouts, carefully considered communal areas and cost-effective materials, we aim to build homes that are safe, easy to maintain and energy efficient.

Efficiency and standardisation on their own will not produce quality developments, however they are important considerations to ensure that all new developments are viable and can contribute to the supply of affordable homes.

These guidelines are intended to improve efficiency in building design and to ensure the limited resources available are spent on areas of developments that will have the greatest positive impact on the residents.

The LDA support and encourage the use of Modern Methods of Construction in the delivery of affordable housing and consider standardisation key to facilitating the increased use of Modern Methods of Construction at the delivery stage.

All guidance, layouts and specifications provided have gone through a rigorous internal technical and cost review process, in addition to external peer review to ensure the optimum solution has been provided. These guidelines are not intended to curtail creativity of the design team or prescribe any particular architectural response, but to provide the design team with a clear brief that will form the basis on which design teams can develop a site-specific response. For a design to be considered successful it should achieve a coalescence of efficiency, quality and place-making.



Donore Project, Dublin

Structure of Guide

This guide is separated into the following four sections:

1

Apartment Design

This section provides specific guidance on how to achieve the LDA design intent for the layouts of apartments. It includes spatial design principles, minimum requirements, and typical layouts arranged by apartment size. This section should be considered a baseline requirement for all design teams to ensure apartment layouts are well designed to provide consistency, quality and certainty across all LDA projects.

2

Building Design

This section provides general guidance to be considered by the design team at the scale of the building. It includes guidance on building layout, building metrics, facade design and communal areas. These items should be carefully considered from concept design to ensure the initial design proposals are rooted in the principles of efficient design and deliver well designed affordable homes with a strong focus on our residents experience of living in these buildings.

3

Technical Considerations

This section sets out areas of technical design for consideration by the design team at Stage 1-2. Prior to submitting planning, the items in this section should be given consideration to ensure the spatial planning takes advantage of any potential opportunities in construction and does not contain any hidden issues or unnecessary inefficiencies that may arise at detailed design.

4

Outline Specification

This section sets out the outline internal specification for both the individual apartments and communal areas within the building. The specification for the apartments is organised by room while the specification for the communal areas is organised by space.

LDA Documents

This guide sits with a suite of LDA briefing documents which apply to all LDA apartment developments. The design team will be provided with a project specific Development Brief outlining the specific project requirements in addition to the relevant LDA standard briefing documents. This guide should be read in conjunction with these documents as outlined below;

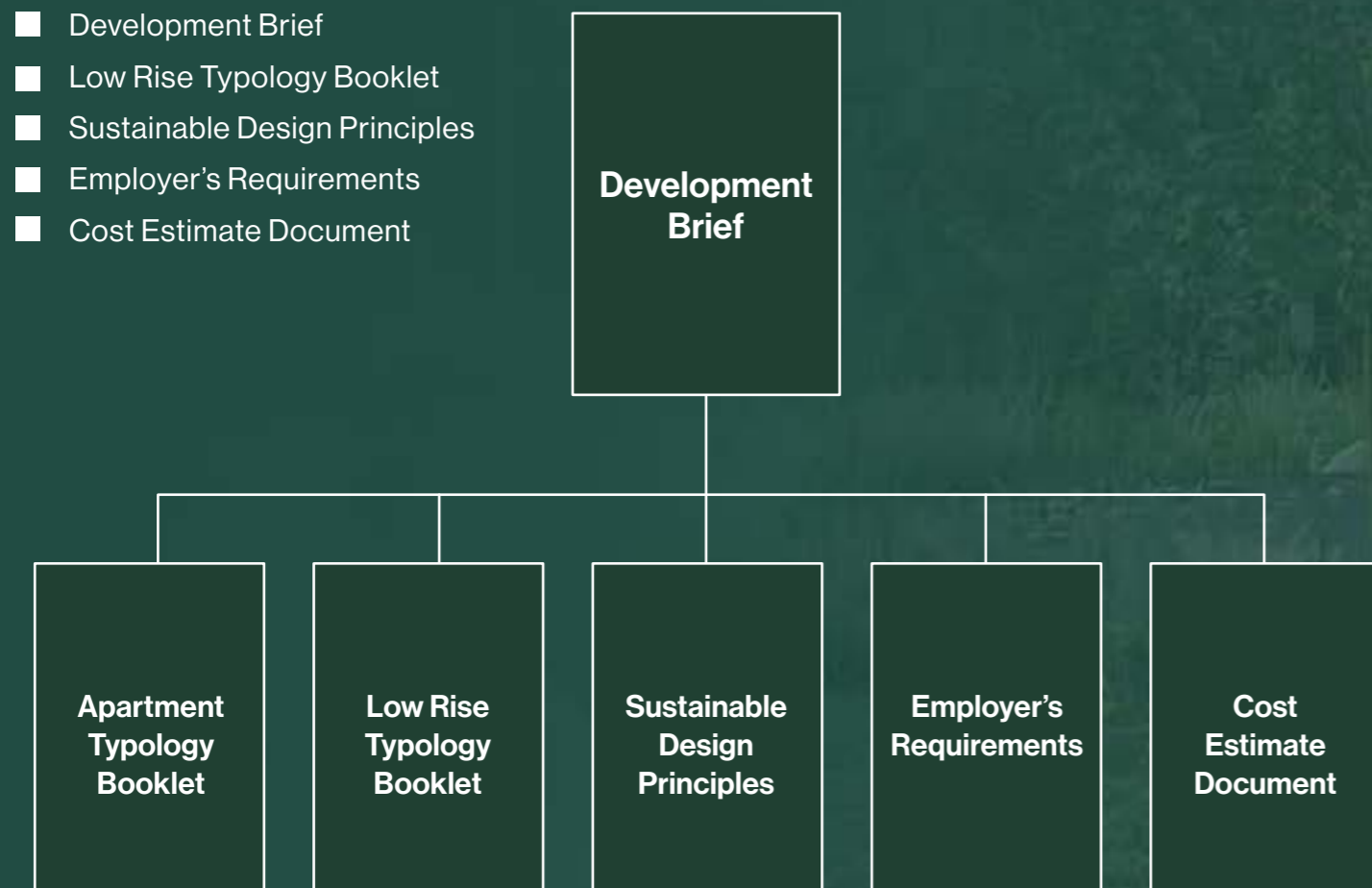

Policy Requirements & Compliance

The design of all apartments must meet the Building Regulations and relevant policy including the *Sustainable Urban Housing-Design Standards for New Apartments* hereafter referred to as the Apartment Standards. The fit out of all cost rental homes must also comply with the *Housing (Standards For Rented Houses) Regulations 2019*.

The information in this document is provided for guidance only and should be verified by the design team on a project by project basis. If the LDA requirements set out in this document cannot be achieved, or the Design Team wish to deviate from these requirements, the Design Team must provide justification for doing so and seek approval from the LDA for doing so.

Dundrum Central, Dublin

Section One Apartment Design



1.1

Design Principles

Apartment layouts should be rigorously developed and refined to ensure the best possible layout is achieved within the project constraints.

Designers should display a practical approach to the layouts so that internally doors do not clash, adequate and usable storage space is provided, and the rooms are designed with end users needs at the forefront of their thinking. All homes need to accommodate space to cook, eat and socialise with family and friends as well as more private spaces for work, study and sleep.

Practical consideration such as where to store a coat upon arrival or where to dry clothes require careful consideration to ensure homes function for the everyday needs of the residents. The following guidance should be considered when designing LDA homes;

1. Simple Shape

Apartment shapes should be simple and orthogonal, avoiding curved, angular or complex shapes.

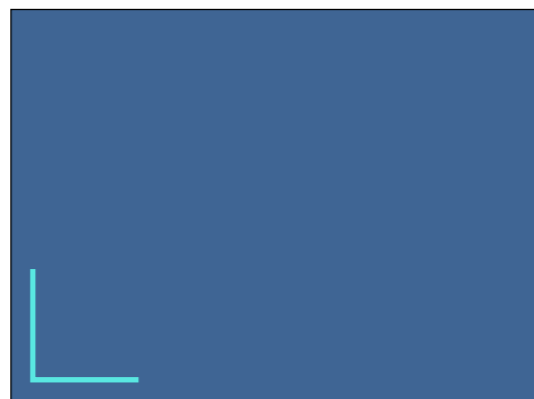

2. Apartment Size

Apartment sizes should comply with minimum areas set out in the Apartment Standards and oversized apartments should be avoided. Apartment widths and depths need careful consideration to ensure areas are kept to a minimum and to avoid wasted space. Rooms should be well proportioned and designed to maximise daylight distribution.

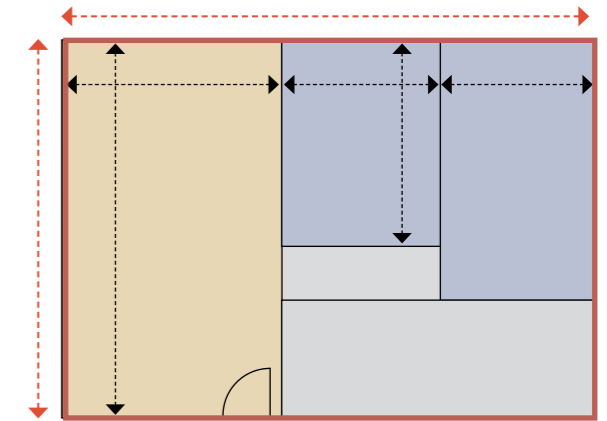

3. Standardisation

Apartments should be standardised across a project and variations minimised. All apartments should use standardise components including balconies, windows, bathrooms, doors, kitchens and wardrobes. Apartments should be designed to accommodate the LDA furniture schedule.

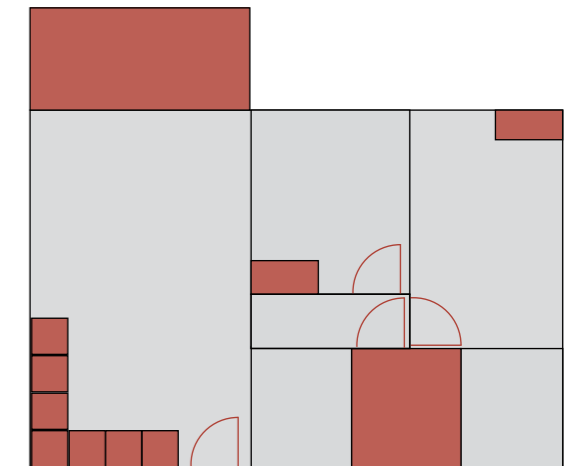

4. Separation of Activities

Activities within a home should be grouped and zoned to provide distinctive spaces for different activities and minimise noise transfer between living rooms and sleeping areas. In open plan living rooms the layout of the kitchen should create a sense of separation from the living space.

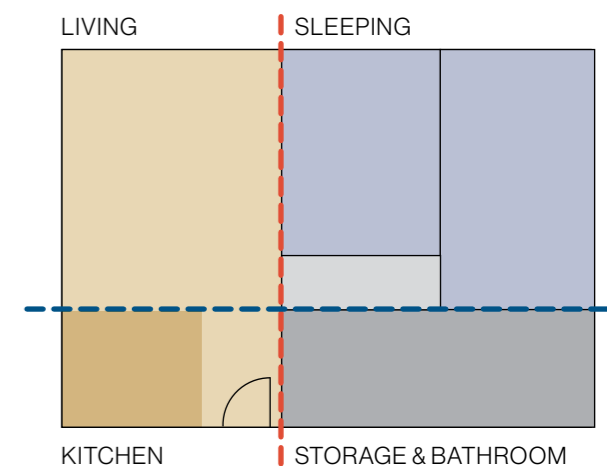

5. Circulation within the Home

All bedrooms and bathrooms should be accessed from a corridor and not directly from the main living space. Corridor lengths should be minimised to maximise usable area within the home.

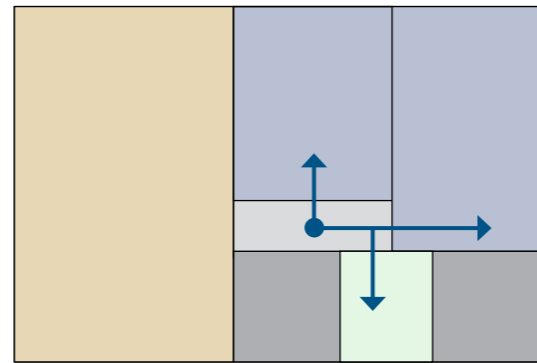

6. Storage

Storage and bathrooms should be located within the area of the home with the least daylight. Storage should be consolidated as much as possible to provide meaningful storage rooms.

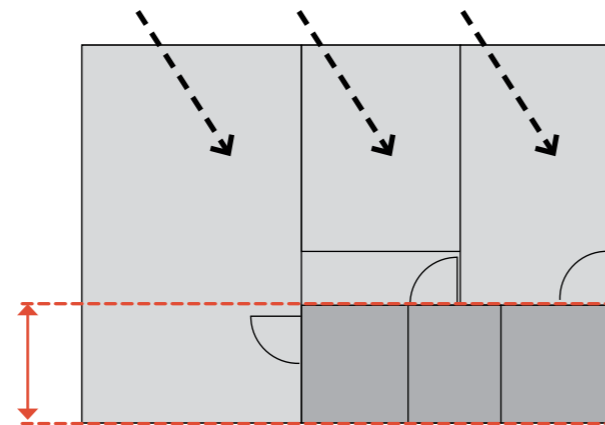

7. Connection to Balcony

Balconies should be designed as an extension of the living space and to be accessed from the main living room. Offsetting of balconies may be required to achieve the required daylight levels.

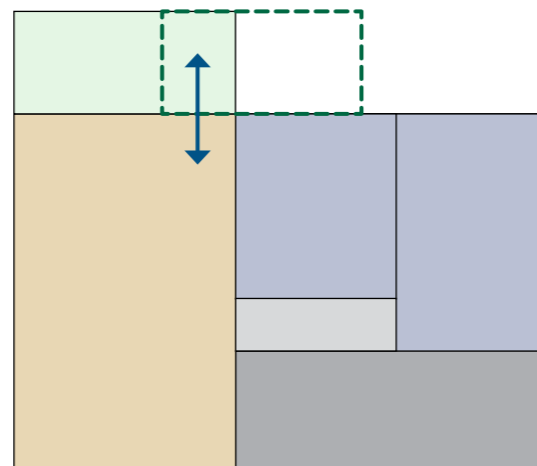

8. Dual Aspect

In all dual aspect homes, the living space should preferably be dual aspect. The placement of doors and windows requires particularly careful consideration in dual aspect homes to ensure adequate wall space is available for furniture such as TV and bookshelves.

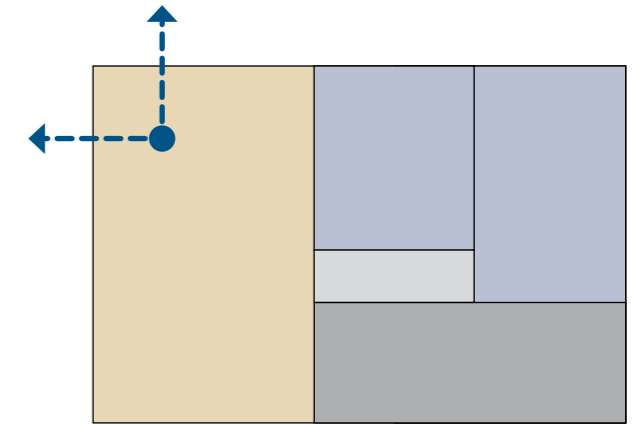

9. Alignment

Internal walls should be aligned where possible to create regular shaped rooms and avoid awkward junctions.

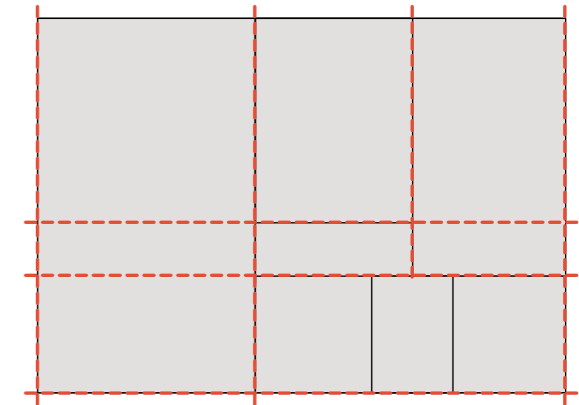

10. Coordination

Apartment layouts should be well coordinated with all building services and structural requirements to avoid layouts being compromised at later stages of the design. Awkward bulkheads, boxing out or exposed services should be avoided.

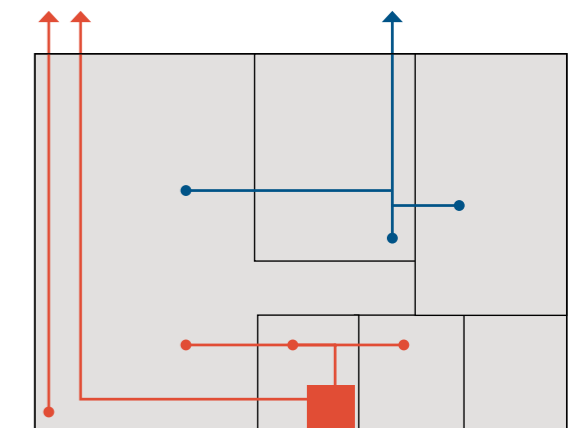

1.2

Minimum Requirements

1.2.1 Combined Living & Dining

All living rooms must be designed to accommodate the typical furniture based on the number of bed spaces provided, in addition to complying with the minimum room areas and widths set out in the Apartment Standards. As a minimum requirement combined living and dining rooms must accommodate the following furniture:

Item	Size
Armchair	850mm X 850mm
2 Seat Sofa	850mm X 1300mm
3 Seat Sofa	850mm X 1800mm

Studio

- A sofa or seating arrangement for two persons*
 - A coffee table (500mm X 1050mm)
 - A flat screen TV
 - A table with dining space for two persons (800mm X 800mm)
- *See table for sofa and armchair sizes.

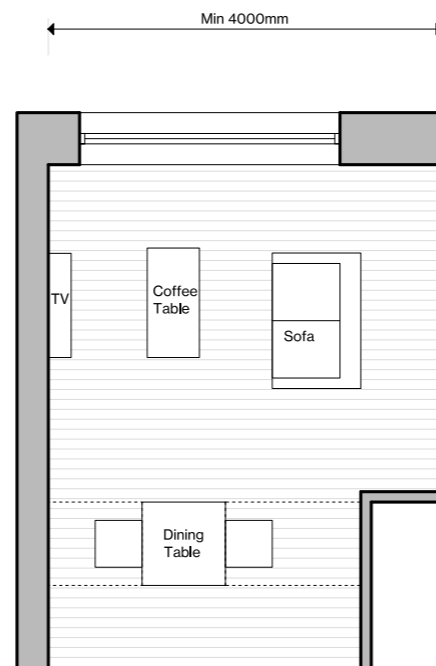

1 Bedroom

- A sofa or seating arrangement for three persons*
 - A coffee table (500mm X 1050mm)
 - A flat screen TV
 - A table with dining space for four persons (800mm X 1200mm)
 - A desk for home working (500mm X 1050mm)
- *See table for sofa and armchair sizes.

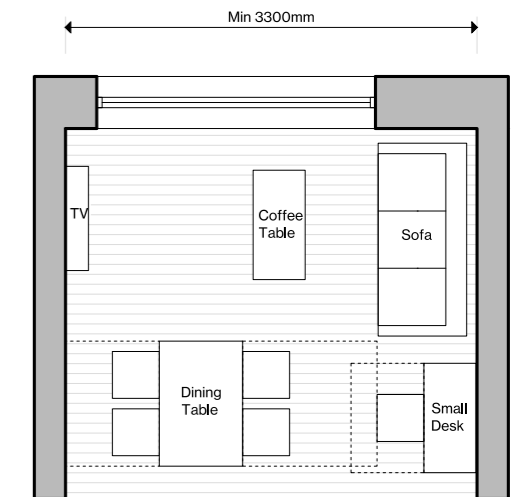

2 Bedroom

- A sofa or seating arrangement for four persons*
 - A coffee table (500mm X 1050mm)
 - A flat screen TV
 - A table with dining space for four persons (800mm X 1200mm)
 - A desk for home working (500mm X 1050mm)
- *See table for sofa and armchair sizes.

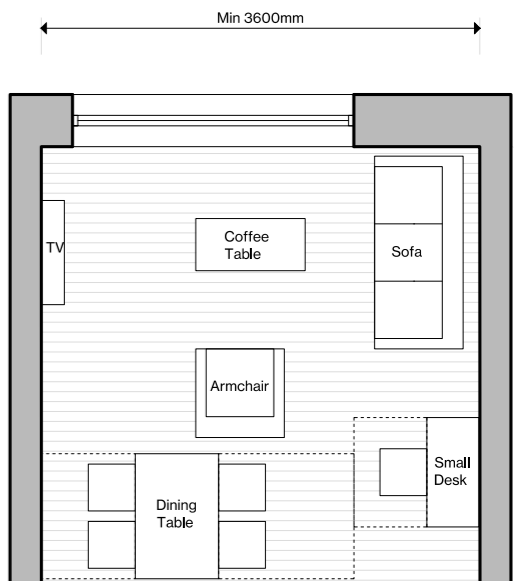

3 Bedroom

- A sofa or seating arrangement for five persons*
 - A coffee table (500mm X 1050mm)
 - A flat screen TV
 - A table with dining space for six persons (800mm X 1800mm)
 - A desk for home working (500mm X 1050mm)
- *See table for sofa and armchair sizes.

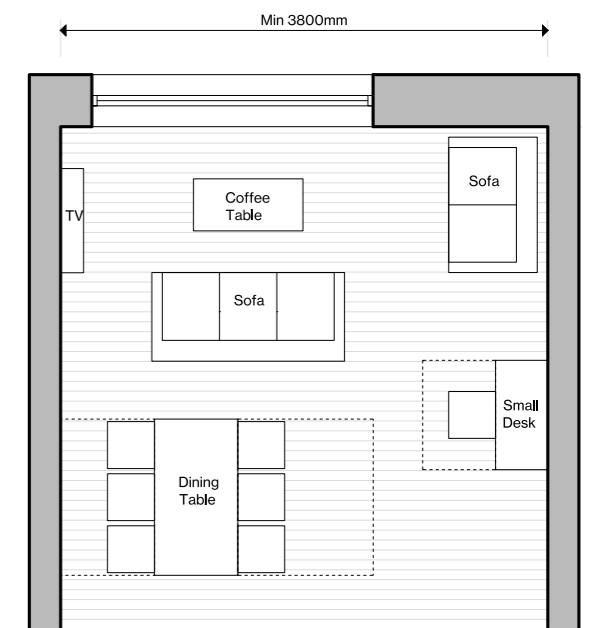

1.2.2 Bedrooms

All bedrooms must be designed to accommodate the typical furniture based on the number of bed spaces provided, in addition to complying with the minimum room areas and widths set out in the Apartment Standards. As a minimum requirement bedrooms must accommodate the following furniture:

Single Bedroom

- Layout to accommodate a standard size single bed (1900mm X 900mm) with a 800mm clear zone to one side and foot of the bed.
- Layout to allow for one bedside lockers with minimum dimensions of 400mm x 400mm.
- Layout to accommodate a wardrobe with minimum dimensions of 900mm x 600mm with an allowance for doors to open without obstruction.
- Consider alternative uses of single bedroom such as home office or separate dining room.

Double or Twin Bedroom

- Layout to accommodate a standard king size bed (2000mm X 1500mm) with a 800mm clear zone around the sides and foot of the bed.
- Layout to allow for two bedside lockers with minimum dimensions of 400mm x 400mm.
- Layout to accommodate a wardrobe with minimum dimensions of 1200mm x 600mm with an allowance for doors to open without obstruction.
- Layout of twin bedroom to accommodate two standard size single beds (1900mm X 900mm) with a 800mm clear zone to one side and foot of the bed.

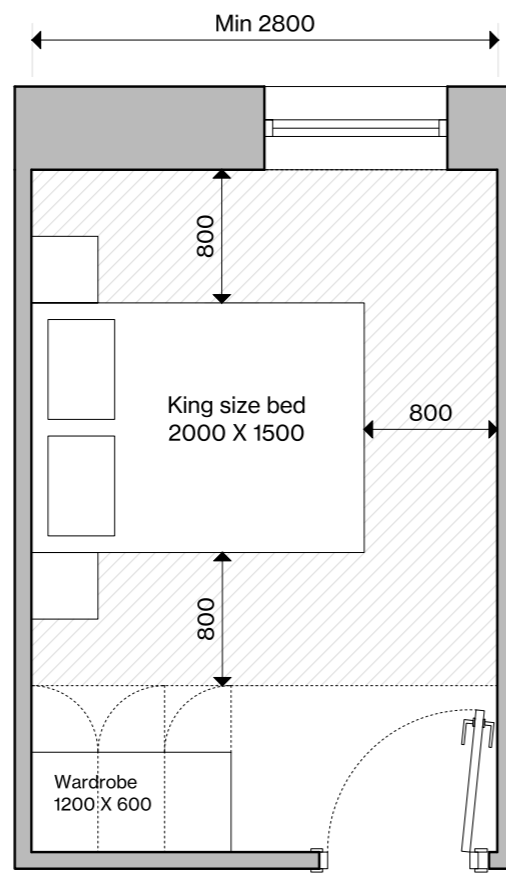
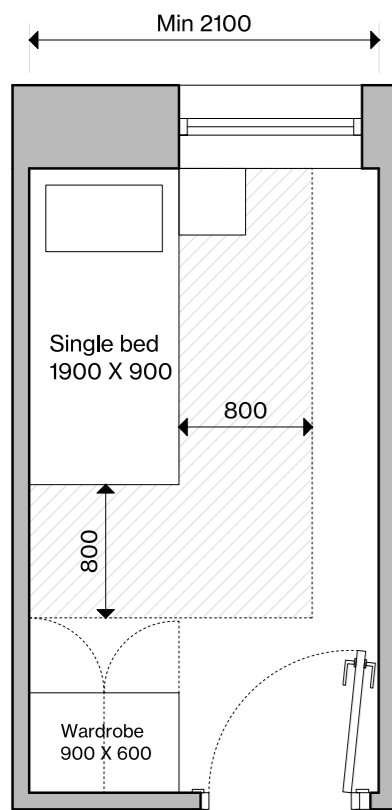

1.2.3 Bathroom

Bathrooms should be designed to ensure they are highly functional, robust, easy to clean and family friendly. Bathrooms should be designed to have simple lines and contemporary appearance. General guidance for space planning of bathrooms within LDA homes:

- Bathroom layouts to allow for pod construction.
- Bathrooms should be standardised across all apartments and variations avoided.
- All bathrooms to be stacked.
- Bathroom doors to be outward opening to maximise manoeuvrability within the bathroom.
- Toilet, sink and bath/shower to be arranged on one wall to facilitate efficient drainage.
- Drainage stack to be included on all layouts. Access for maintenance to be given careful consideration. Ideally access should be provided from adjacent store room.
- The typical bathroom and shower room drawings that follow set out the LDA minimum requirements.
- The number of bathroom/shower rooms/WCs required in each apartment types is set out in the table below.
- Shower door/bath screen opening should be carefully coordinated to avoid any clash with the toilet or wash hand basin.
- Refer to the outline specification for details on bathroom finishes.

Apartment Type	Requirement
Studio	Bathroom or Shower Room
1B2P	Bathroom
2B3P	Bathroom
2B4P	Bathroom
3B5P	Bathroom and WC

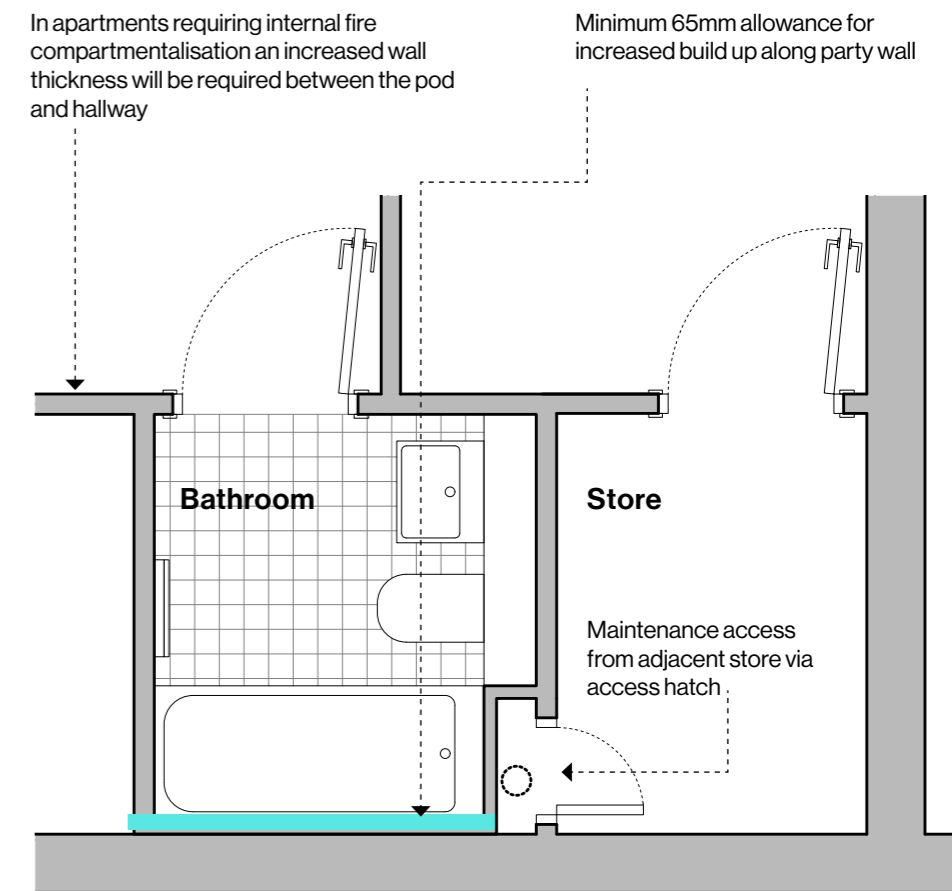

Allowance of pod construction and access for maintenance

1.2.3 Bathroom

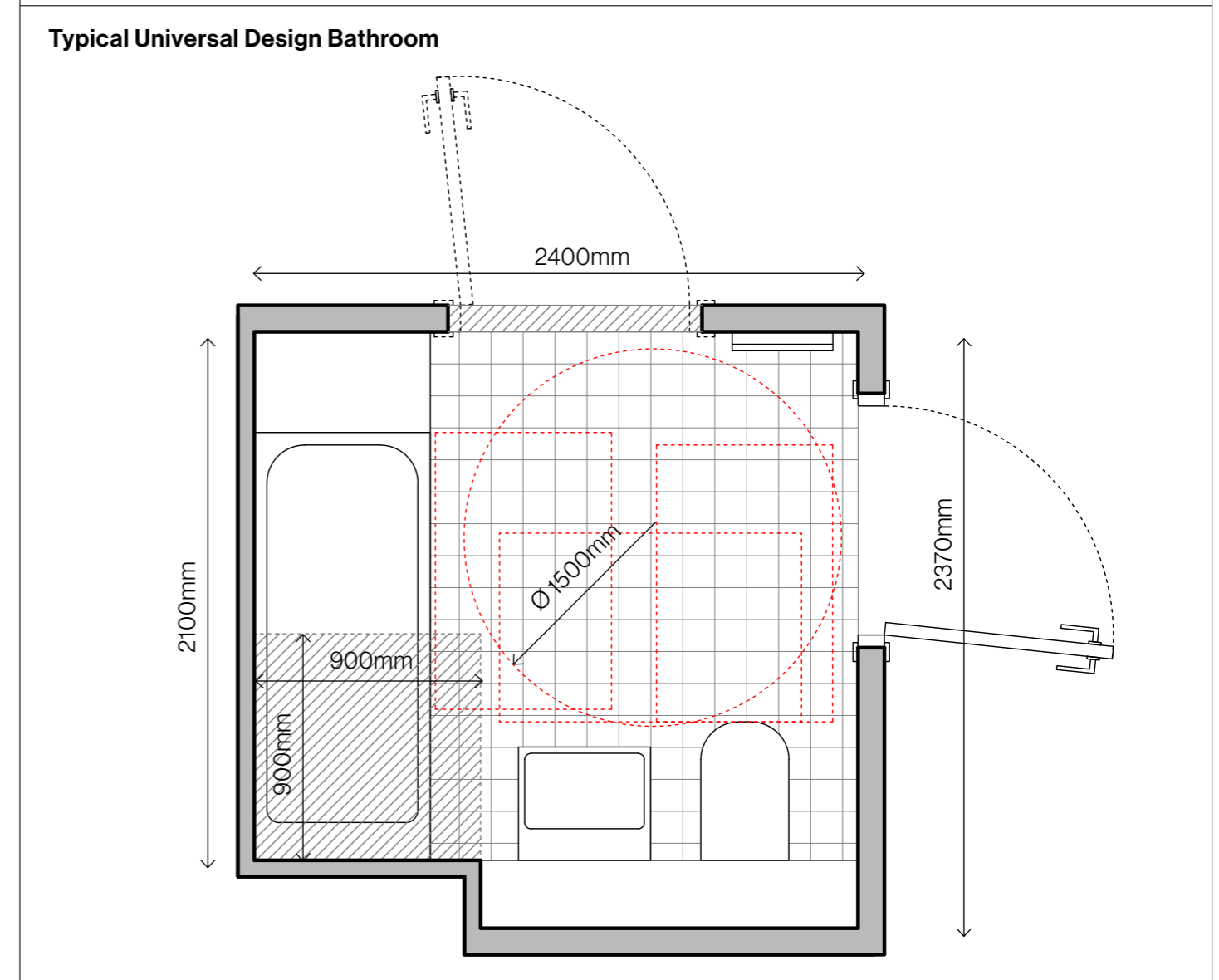
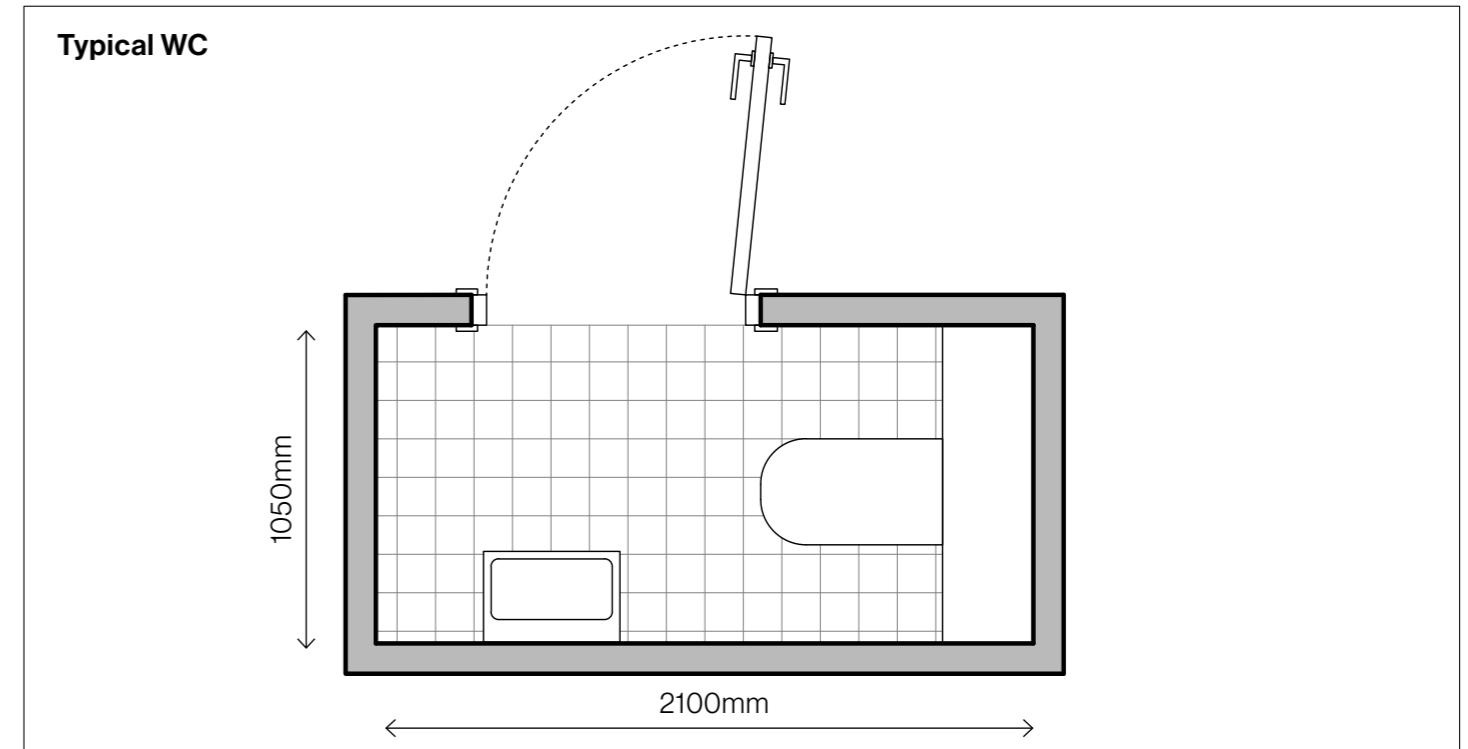
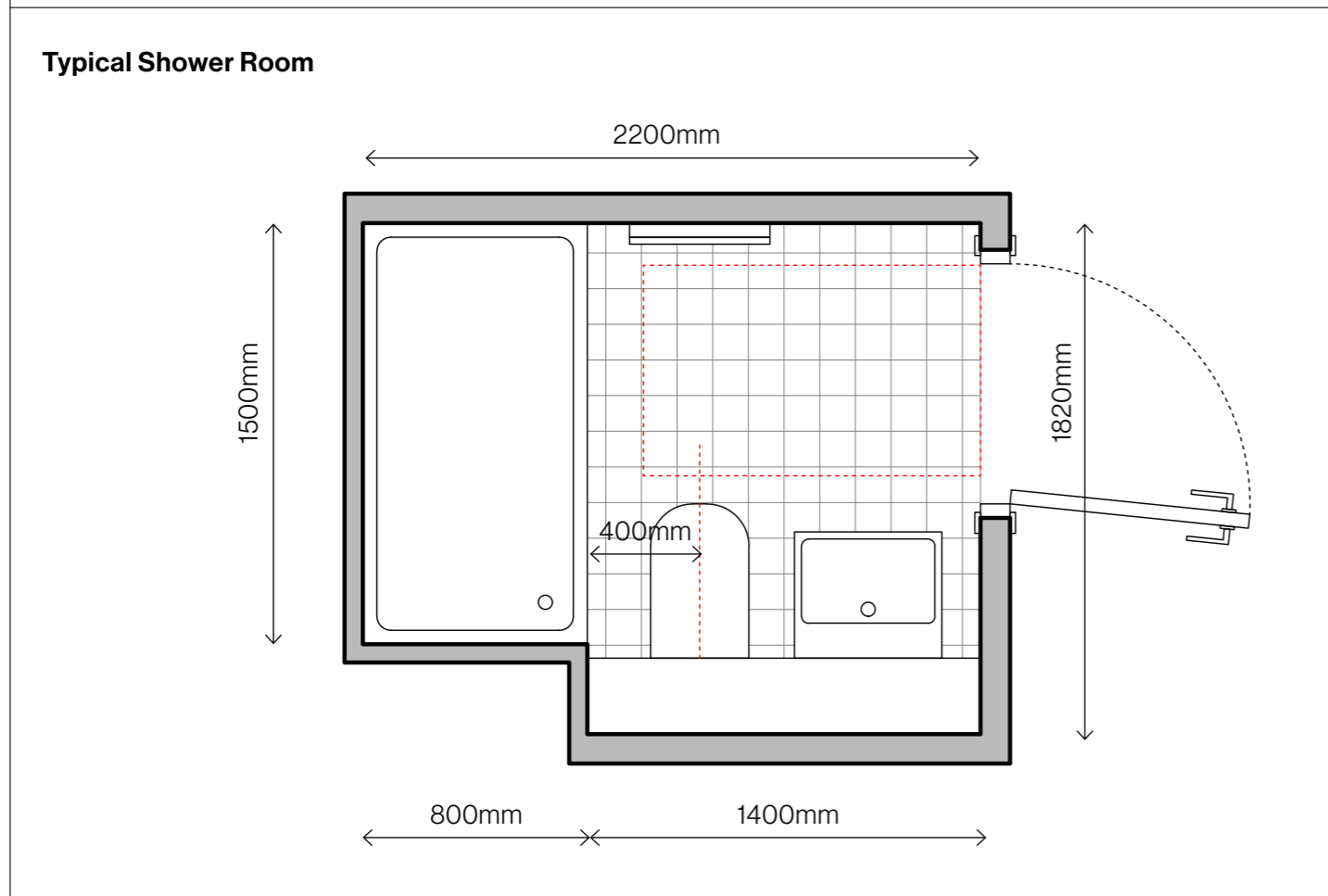
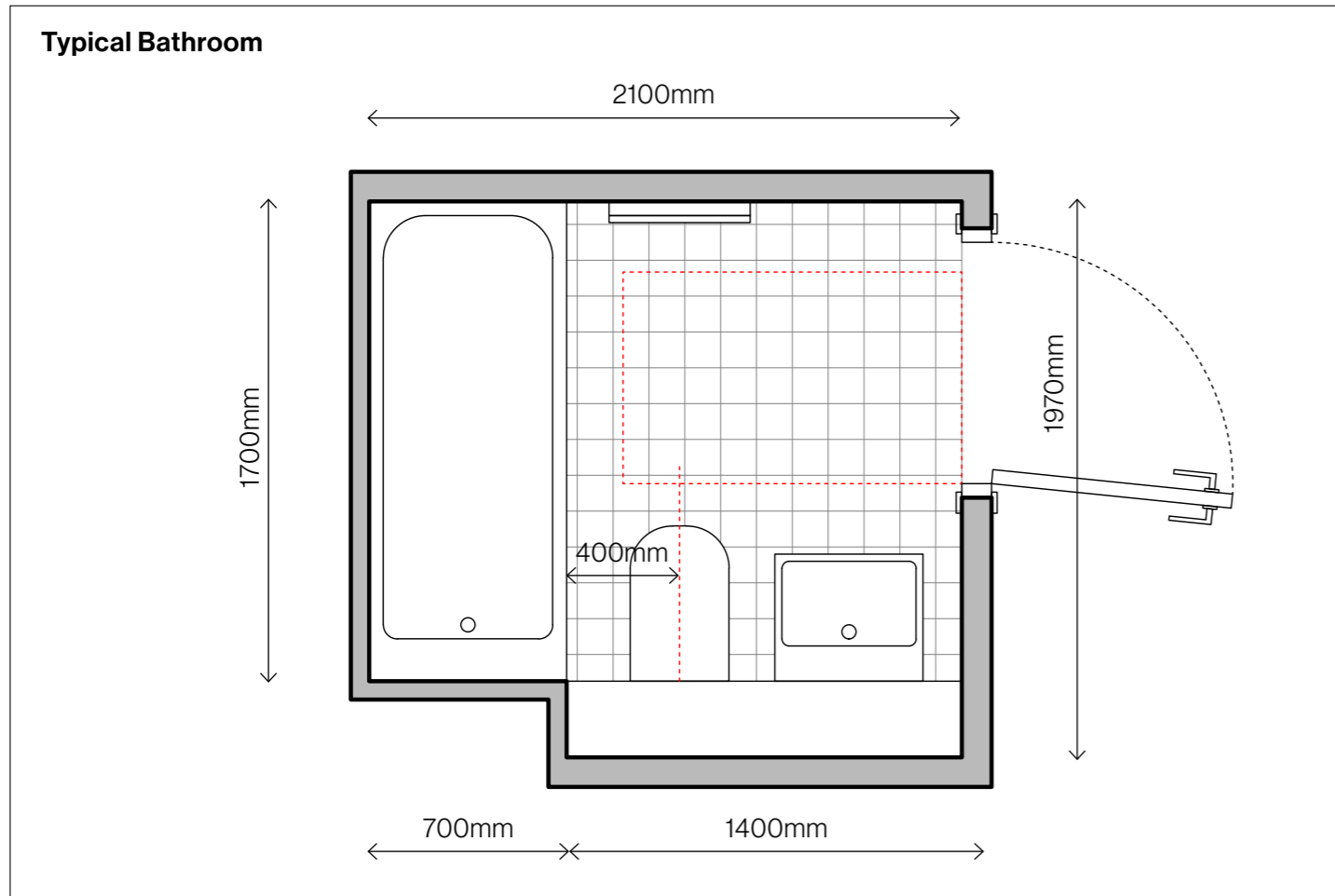

1.2.4 Kitchens

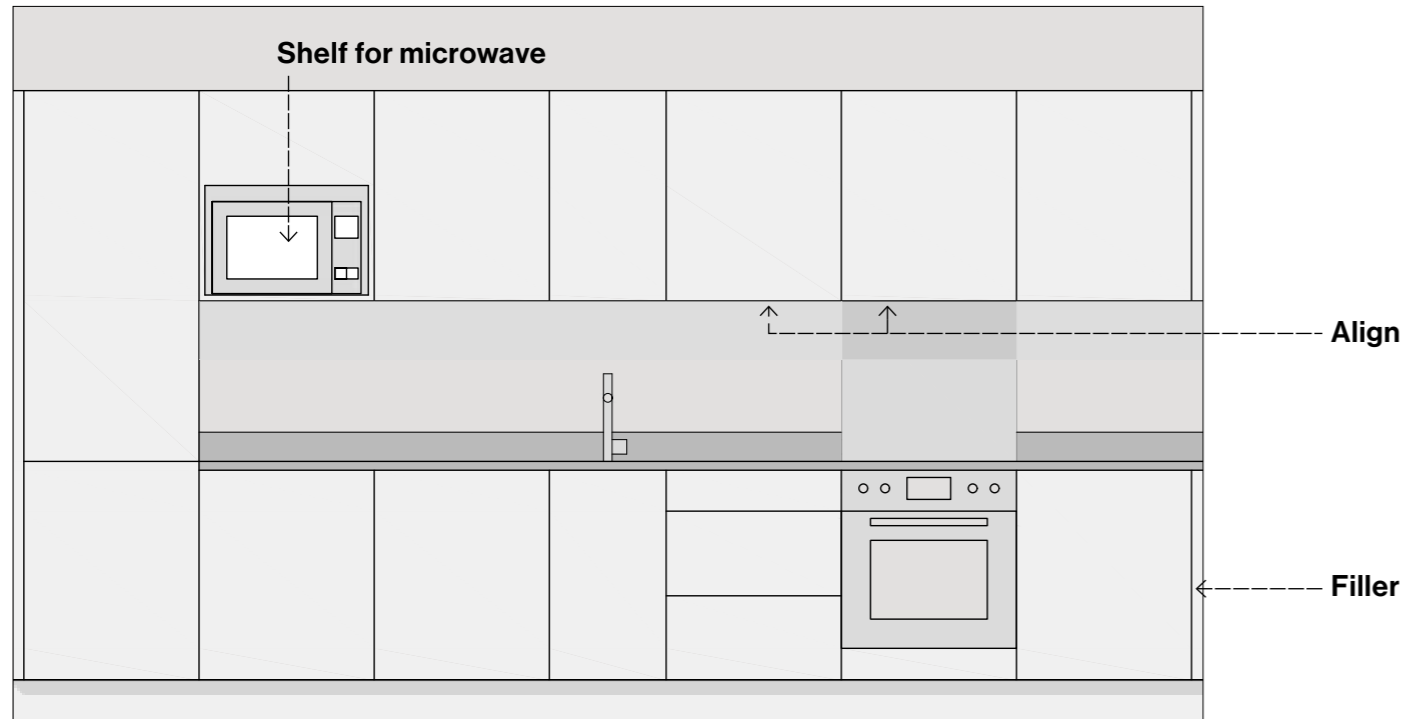

Indicative kitchen elevation

Kitchens should be provided with adequate storage space for food, cutlery, crockery, small appliances, and adequate worktop space for food preparation. Kitchens should be designed to have simple and contemporary appearance.

- Kitchens should be designed to have clean and simple lines.
- Kitchens should be standardised, and the number of kitchen types should be minimised.
- Kitchens should be designed based on a standard kitchen unit module of 600mm with an allowance for fillers pieces at wall abutments to accommodate construction tolerances.
- Allow a minimum distance of 1200mm between facing base units to allow for circulation and opening of doors.
- Allowance to be made behind all base units where a sink or dishwasher is located for waste and water pipe installation.
- Allow for a minimum of 300mm clear worktop area each side of the hob and sink.
- Socket locations should be considered as part of the kitchen design.
- The fridge/freezer should be positioned at the end of a run of units.
- A shelf in the overhead cabinets should be provided to house a free standing microwave.
- Washing machines should not be located in open plan kitchens.
- Refer to outline specification for list of appliances required.
- The following kitchen furniture schedule should be shown on all dwelling plans to demonstrate compliance with LDA requirements.
- A dishwasher should be located under the draining board adjacent to the sink.

	Studio
	1B2P
	2B3P
	2B4P
	3B5P

BU: Base unit. FF: Fridge freezer.

1.2.5 Storage

Storage should be designed to be practical, usable and affordable to deliver. General guidance for storage within LDA homes:

- Storage must be designed to comply with the storage requirements set out in the Apartment Standards.
- Provide storage rooms in lieu of cabinetry.
- Avoid including wardrobe space towards the storage requirement.
- Consider practical accessible space. Avoid long narrow storage rooms.
- Provide storage room in the form of a utility room to accommodate a washing machine, drier and area to dry clothes. Utility room to include air extraction. Drier may be stacked above the washing machine if required.
- Connection to a drainage stack to be considered in rooms containing washing machine.

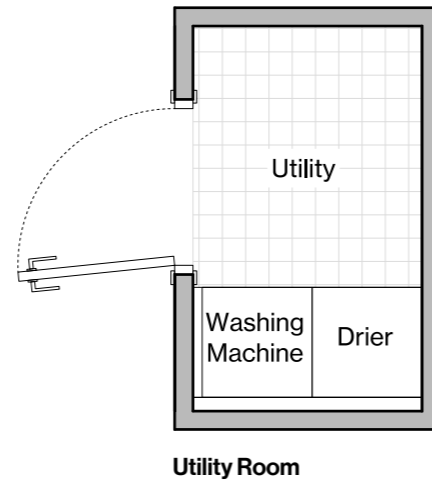

1.2.6 M&E Cupboard

Placement of M&E systems should be carefully considered to avoid encroaching on usable space. General guidance for M&E systems within LDA homes:

- All M&E systems should be contained within a dedicated M&E cupboard.
- M&E cupboards should be stacked.
- M&E cupboards may sit within a storage room however the area dedicated to services should not be counted towards the storage requirement. The combined area of the storage and services should not exceed 3.5sqm.
- If M&E cupboards are provided within storage rooms the M&E services should be enclosed within a secure cabinet.
- Connection to a drainage stack to be considered for M&E cupboards if required.
- Dimensions of M&E cupboard to be confirmed by design team however until confirmed allow a minimum of 700mm x 700mm.

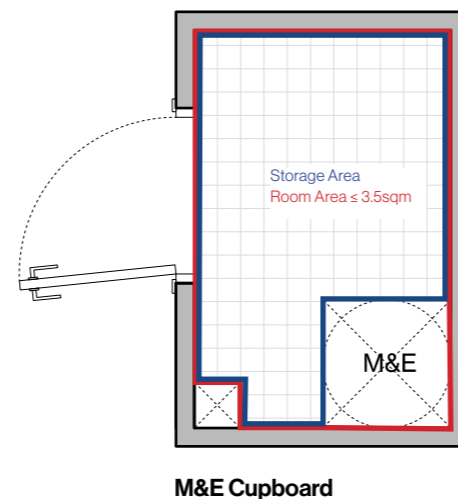

1.2.7 Internal Doors & Corridors

All doors and corridors to be designed to achieve the effective clear widths set out in Part M TGD. General guidance for space planning of internal doors and corridors within LDA homes:

- Door sizes should be standardised and variations should be minimised.
- Door sizes should be based on standard door leaves.
- Structural openings should be adequate to allow required effective clear widths to be achieved using a standard timber door set construction.
- Door nibs require careful consideration to ensure adequate room is provided for architraves and ironmongery.
- Internal corridors should be minimum of 1050mm wide, with increased allowance provided when a door is located at the end of the corridor.
- Entrance halls should be a minimum of 1200mm wide.
- Below is a worked example for a 775mm clear width door provided for illustrative purposes only. All information should be verified by the design team.

Worked Example				
Effective Clear Width	Door Leaf	Structural Opening	Required to open beyond 90	Corridor Width Required
775mm	864mm	955mm	Yes	1140mm

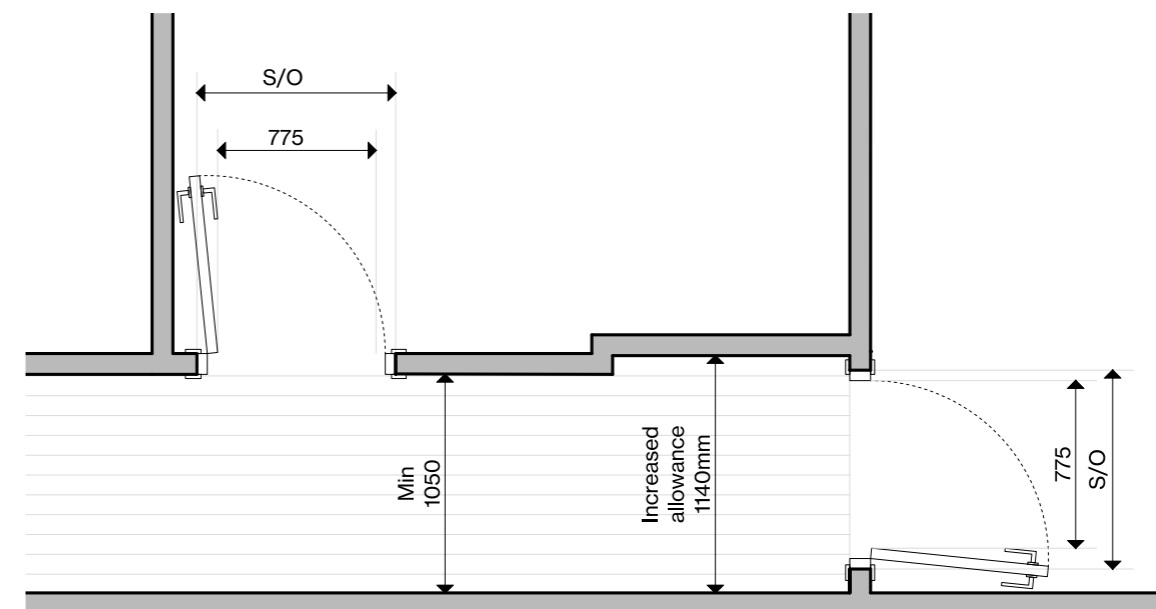

Internal doors and corridors. Refer to TGD Part M

1.2.8 Private Amenity

All balconies should be designed to be usable as possible and act as an extension of the living space. General guidance for space planning of private amenity within LDA homes:

- All balconies must be designed to comply with the private amenity requirements set out in the Apartment Standards
- Private amenity space must provide sufficient space to allow for a small table and two chairs.
- Private amenity must have a minimum internal width of 1500mm.
- Where balconies are offset to achieve the required daylight levels, the balcony should overlap with the living room by a minimum of 1.2m.
- Consideration should be given to the UDH+ requirements for private amenity space to reduce the variation of balcony types, such as providing ground level or podium level private amenity in lieu of balconies.
- Standard balconies should be used and variations should be minimised.
- Balconies should be designed to allow for off-site fabrication.
- Private amenity must be accessible from the main living area and should have level access.
- On smaller projects where there may be less than 40 of any one balcony type, consideration should be given to increasing the balcony size of the Studio and 2B3P to align with the 1B2P and 2B4P balcony sizes respectively.

Apartment Type	Requirement	Balcony Type
Studio	4sqm	Type 01
1 Bedroom 2 Person	5sqm	Type 02
2 Bedroom 3 Person	6sqm	Type 03
2 Bedroom 4 Person	7sqm	Type 04
3 Bedroom 5 Person	9sqm	Type 05

Typical Balcony

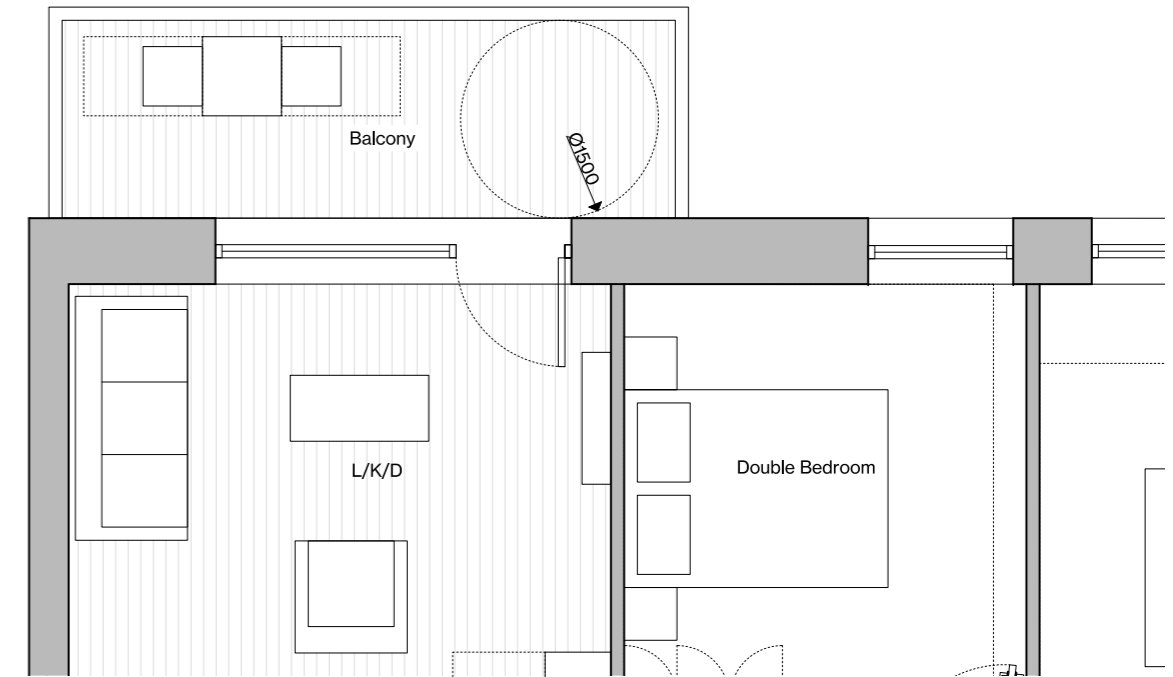

Offset Balcony

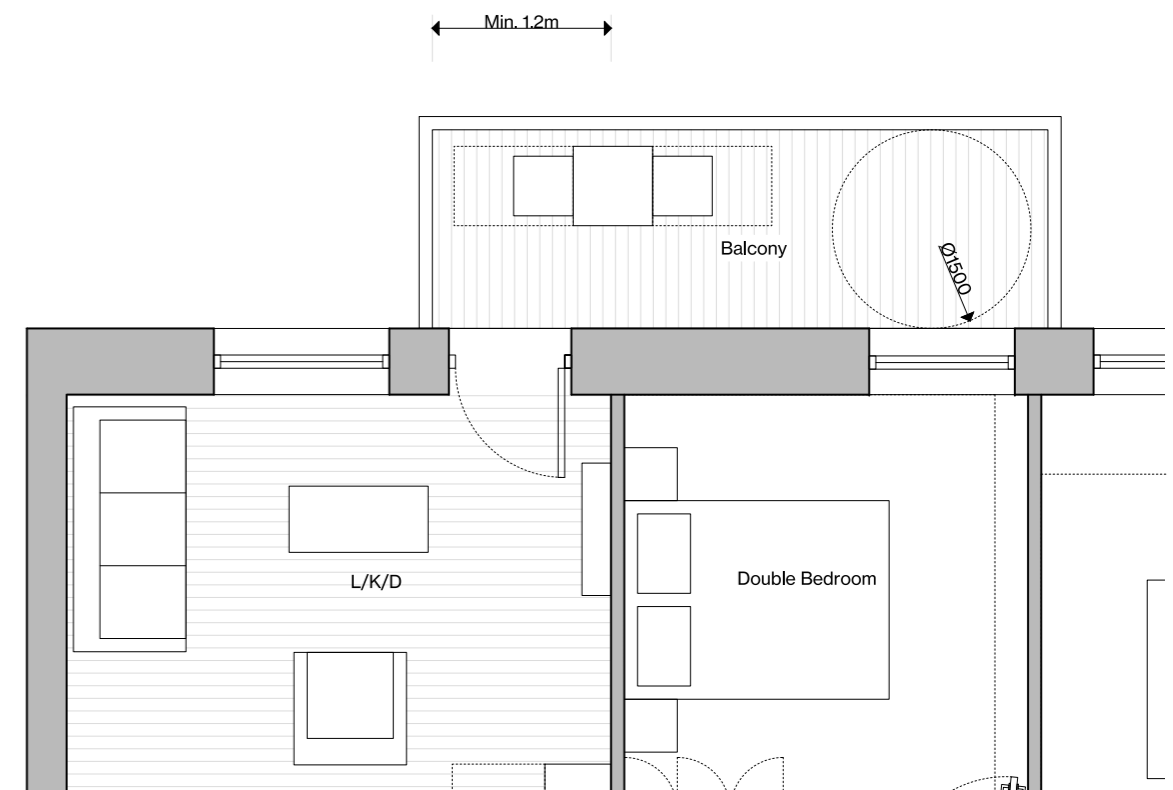

1.3

Typical Apartment Layouts

The following section includes a selection of apartment layouts that meet the LDA design principles and minimum requirements set out earlier in this document. Open plan layouts are generally preferred, however corridor variants are provided in order to reduce travel distances at corridor ends. The following layouts assume a sprinkler system is provided.

The Apartment Standards require the majority of all apartments in a scheme to exceed the minimum floor area standard by a minimum of 10%. The selection of the following LDA preferred apartment types has been informed by this requirement. Apartments that exceed the minimum floor area standard by 10% are hereafter referred to as 10% overs.

All 1B2P and 2B3P apartments have been made 10% overs as these apartment types benefit most from the additional area while having the smallest impact on the overall building area. The 3B5P apartments have also been made 10% overs given the challenges of making

this apartment type work within the minimum area standard. 10% over variants replace the standard size variant to reduce apartment types i.e. a minimum sized variation of a 1B2P has not been provided. The approach to 10% overs will depend on the project specific mix.

The following apartment types are given a reference based on the number of bed-spaces, with a suffix to denote the variation. E.g. The first 1B2P is Type 2A. Additional apartment layouts are included in the appendix for buildings without sprinklers and Universal Design Homes.

Apartment Type	10% Over	Open-Plan	Corridor	Reference
Studio		■		1A
1B2P	■	■		2A
2B3P	■	■		3A
2B4P		■		4A
2B4P			■	4B
3B5P	■		■	5A

Open Plan

Corridor

Studio		
1B2P (10% Over)		
2B3P (10% Over)		
2B4P		
3B5P (10% Over)		

1.3.1 Studio Type 1A

	Provided	Minimum
Living, Kitchen, Dining, Bed-space	30m ²	30m ²
Storage	3m ²	3m ²
Apartment Area	38.6m²	37m²
Balcony	4m ²	4m ²

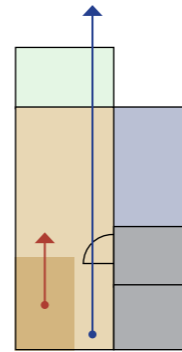

1.3.2 One Bedroom Two Person (10% Over) Type 2A

	Provided	Minimum	10% Over
Living, Kitchen, Dining	27m ²	23m ²	
Double Bedroom	11.4m ²	11.4m ²	
Storage	4.6m ²	3m ²	
Apartment Area	50m²	45m²	49.5m²
Balcony	5m ²	5m ²	

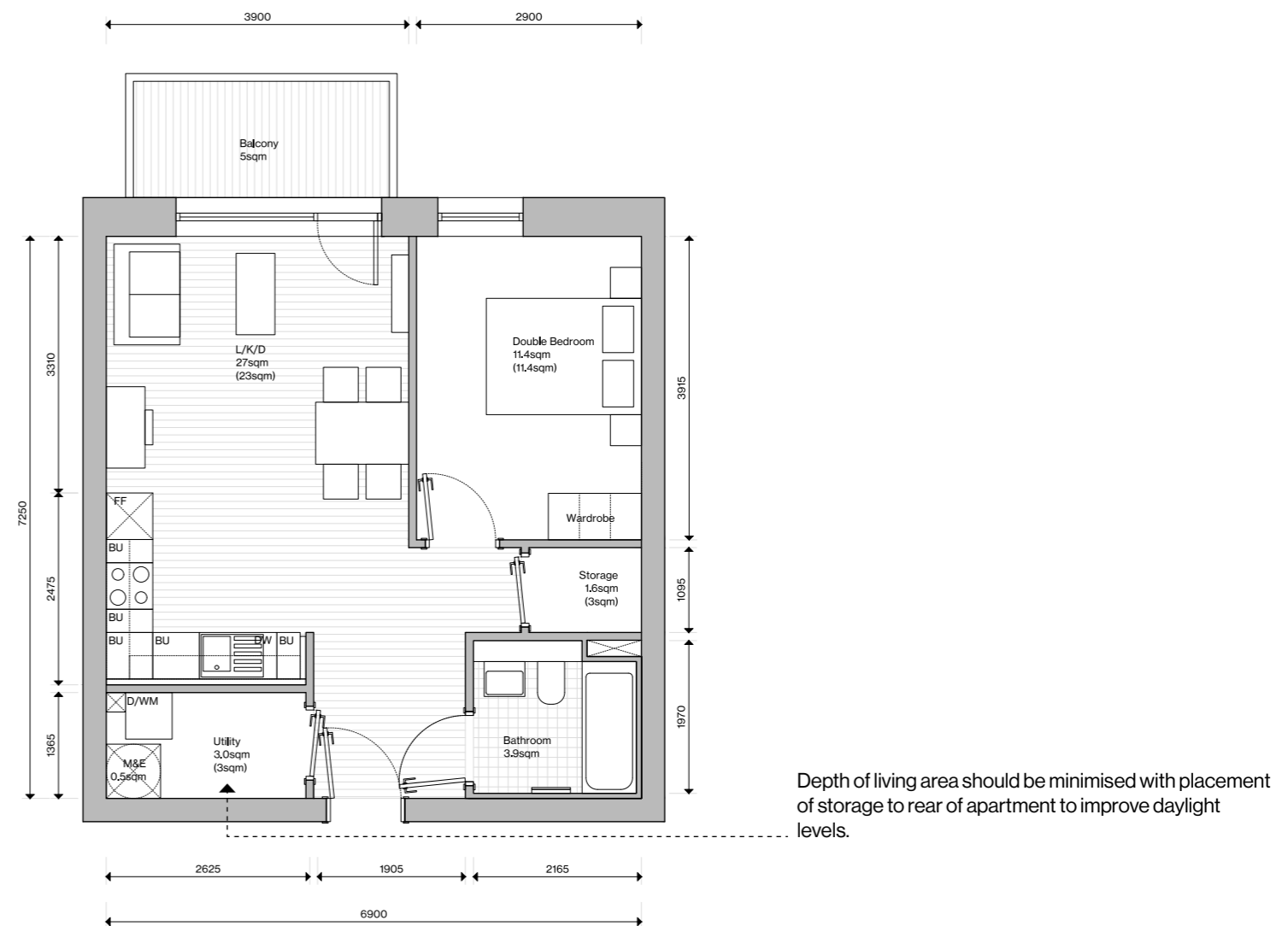
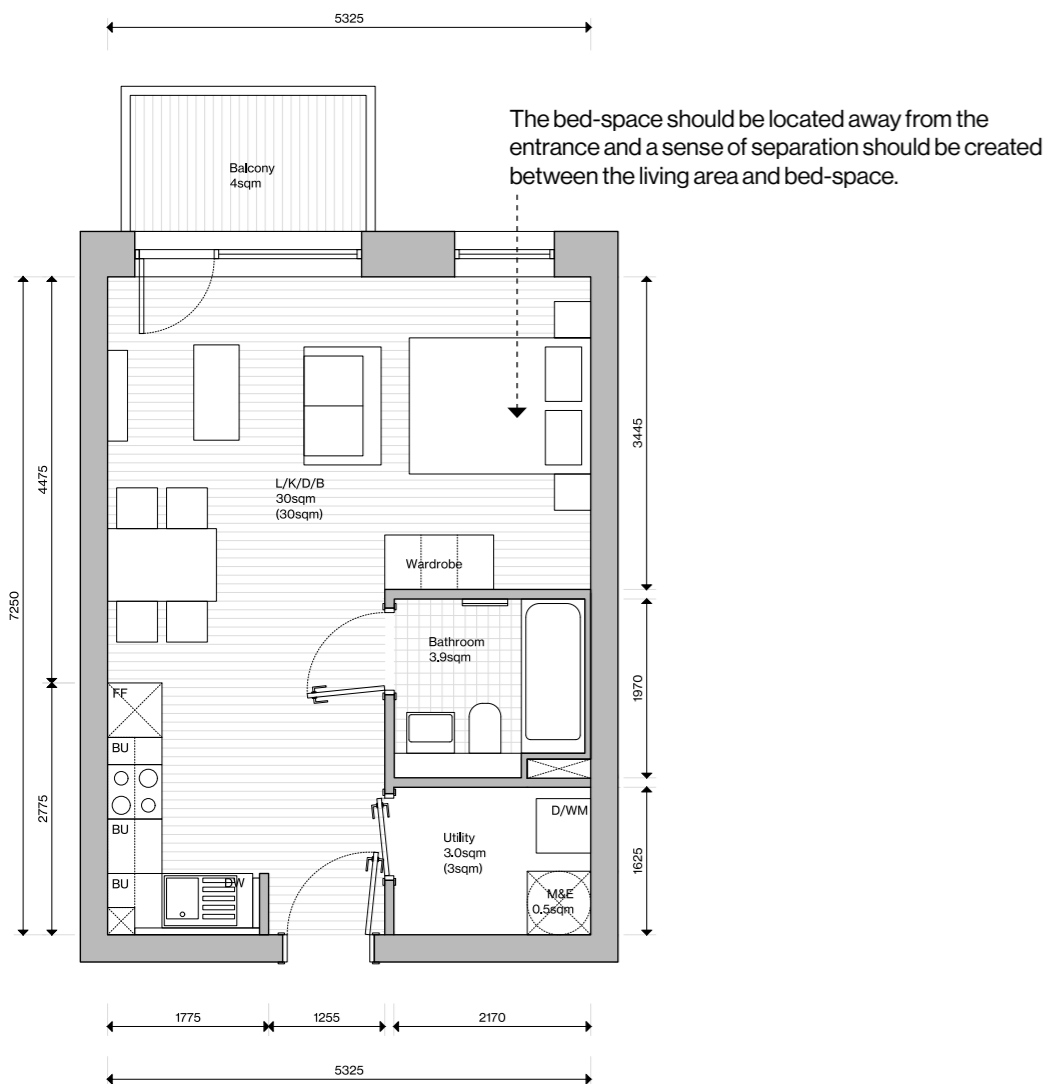
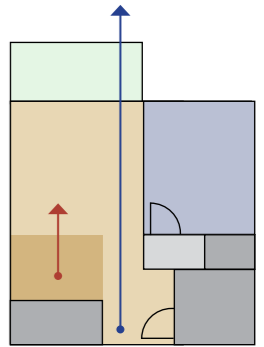

1.3.3 Two Bedroom Three Person (10% Over)

Type 3A

	Provided	Minimum	10% Over
Living, Kitchen, Dining	30m ²	28m ²	
Single Bedroom	9.4m ²	7.1m ²	
Twin Bedroom	13.3m ²	13m ²	
Storage	6m ²	5m ²	
Apartment Area	69.6m²	63m²	69.3m²
Balcony	6m ²	6m ²	

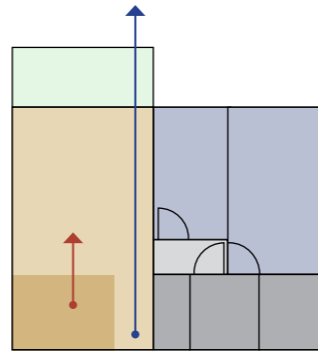

1.3.4 Two Bedroom Four Person (Open plan)

Type 4A

	Provided	Minimum
Living, Kitchen, Dining	32m ²	30m ²
Double Bedroom	11.4m ²	11.4m ²
Twin Bedroom	13.5m ²	13m ²
Storage	6.5m ²	6m ²
Apartment Area	73.68m²	73m²
Balcony	7m ²	7m ²

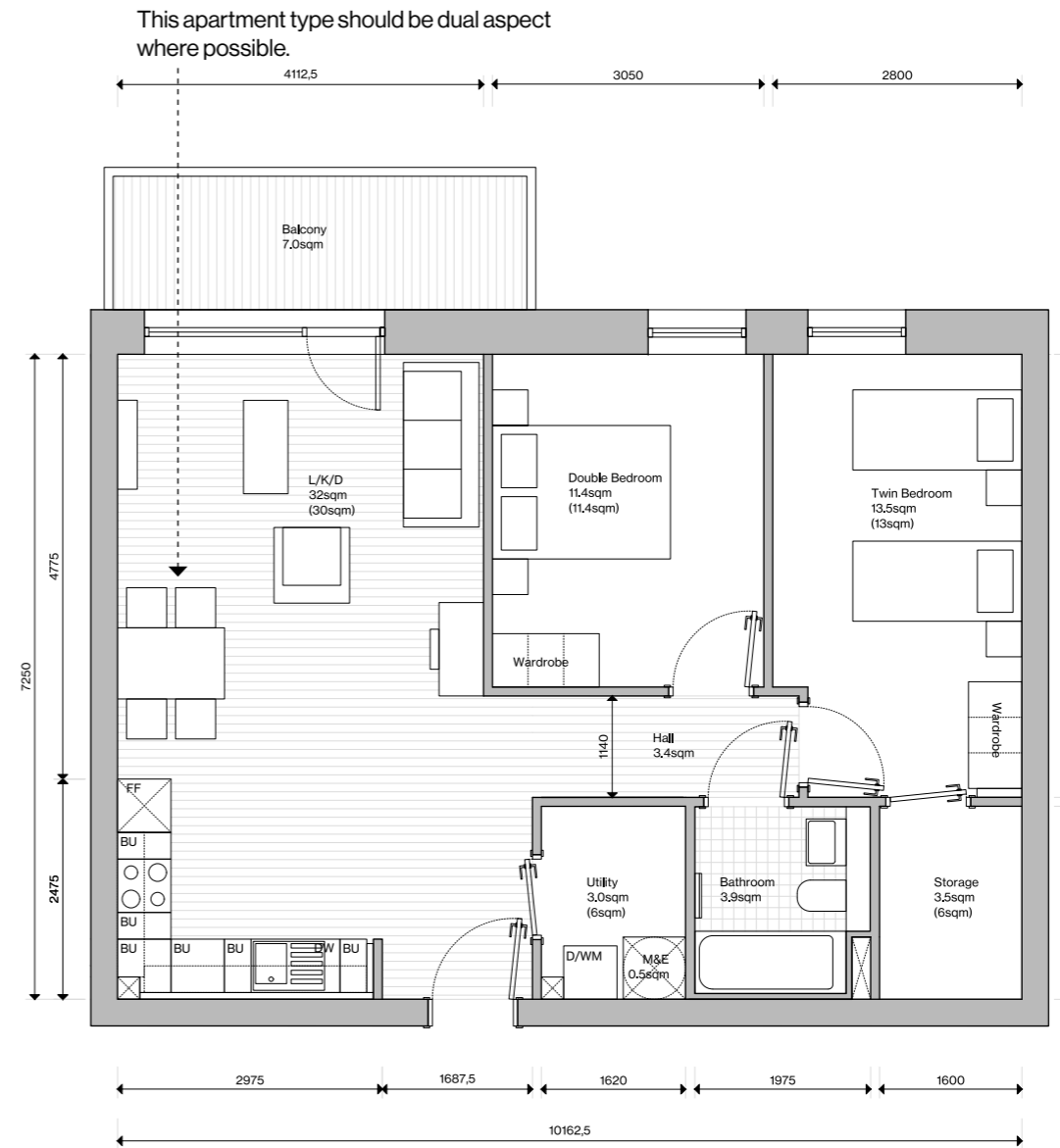
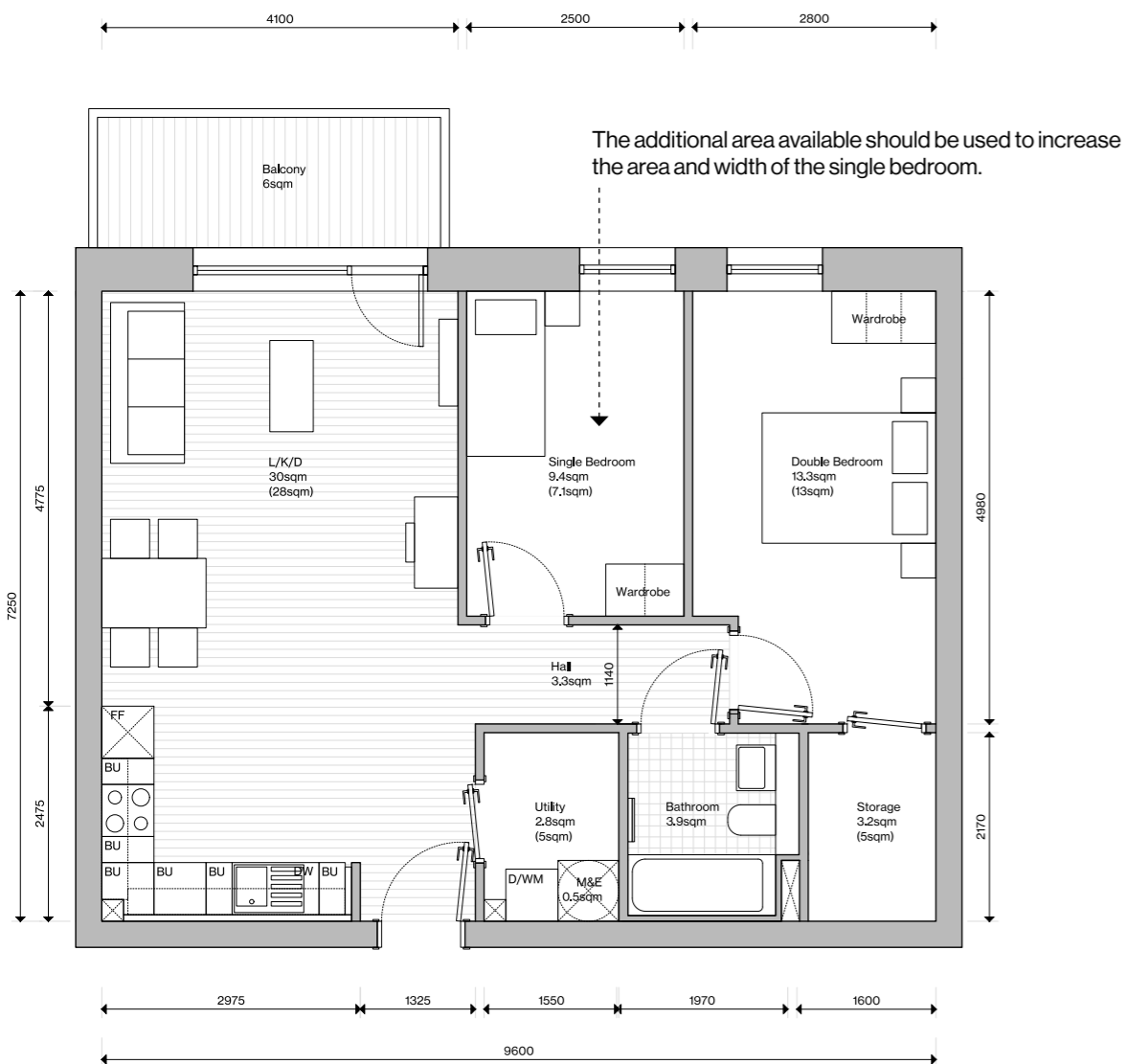
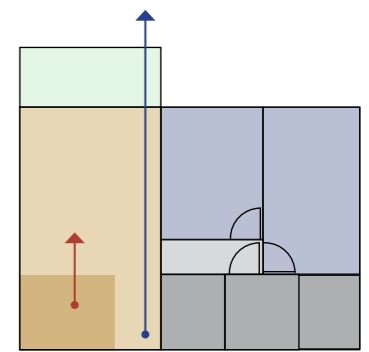

1.3.5 Two Bedroom Four Person (Corridor)

Type 4B

	Provided	Minimum
Living, Kitchen, Dining	30m ²	30m ²
Double Bedroom	11.4m ²	11.4m ²
Twin Bedroom	13.1m ²	13m ²
Storage	6m ²	6m ²
Apartment Area	74.5m²	73m²
Balcony	7m ²	7m ²

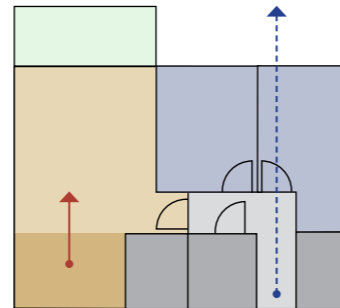

1.3.6 Three Bedroom Five Person (10% Over & Corridor)

Type 5A

	Provided	Minimum	10% Over
Living, Kitchen, Dining	35m ²	34m ²	
Double Bedroom	11.4m ²	11.4m ²	
Twin Bedroom	13.3m ²	13m ²	
Single Bedroom	8.6m ²	7.1m ²	
Storage	9.1m ²	9m ²	
Apartment Area	99m²	90m²	99m²
Balcony	9m ²	9m ²	

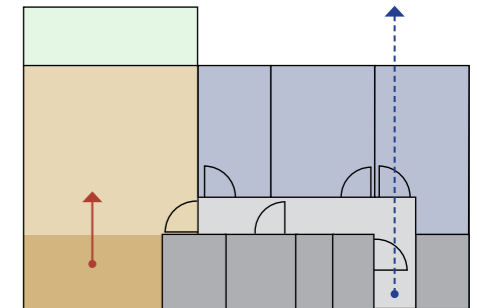

This apartment type should be dual aspect where possible.

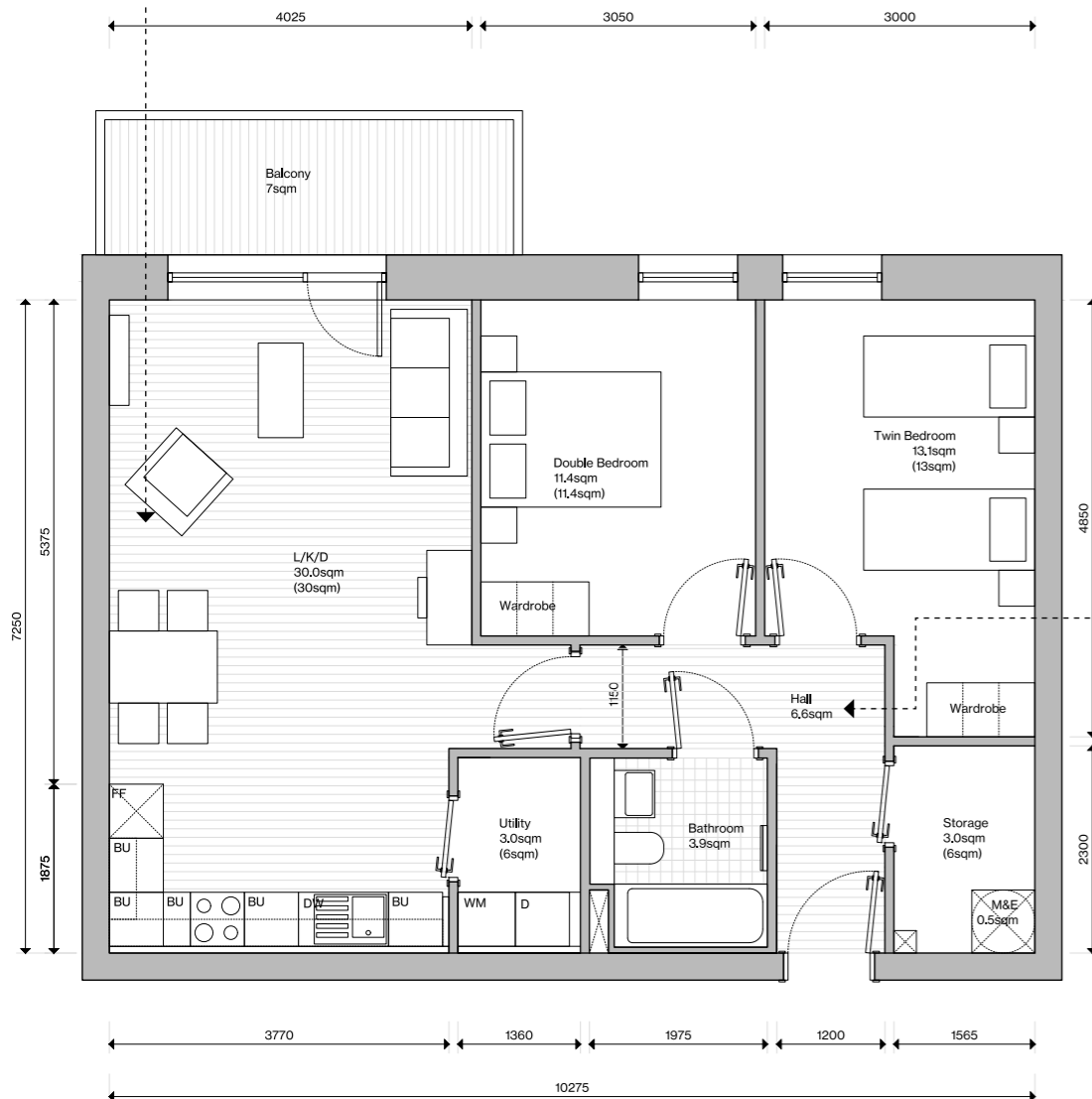

The corridor variation of the two bed four person should be used at the extremities of a building to reduce travel distances where required.

This apartment type should be dual aspect where possible.

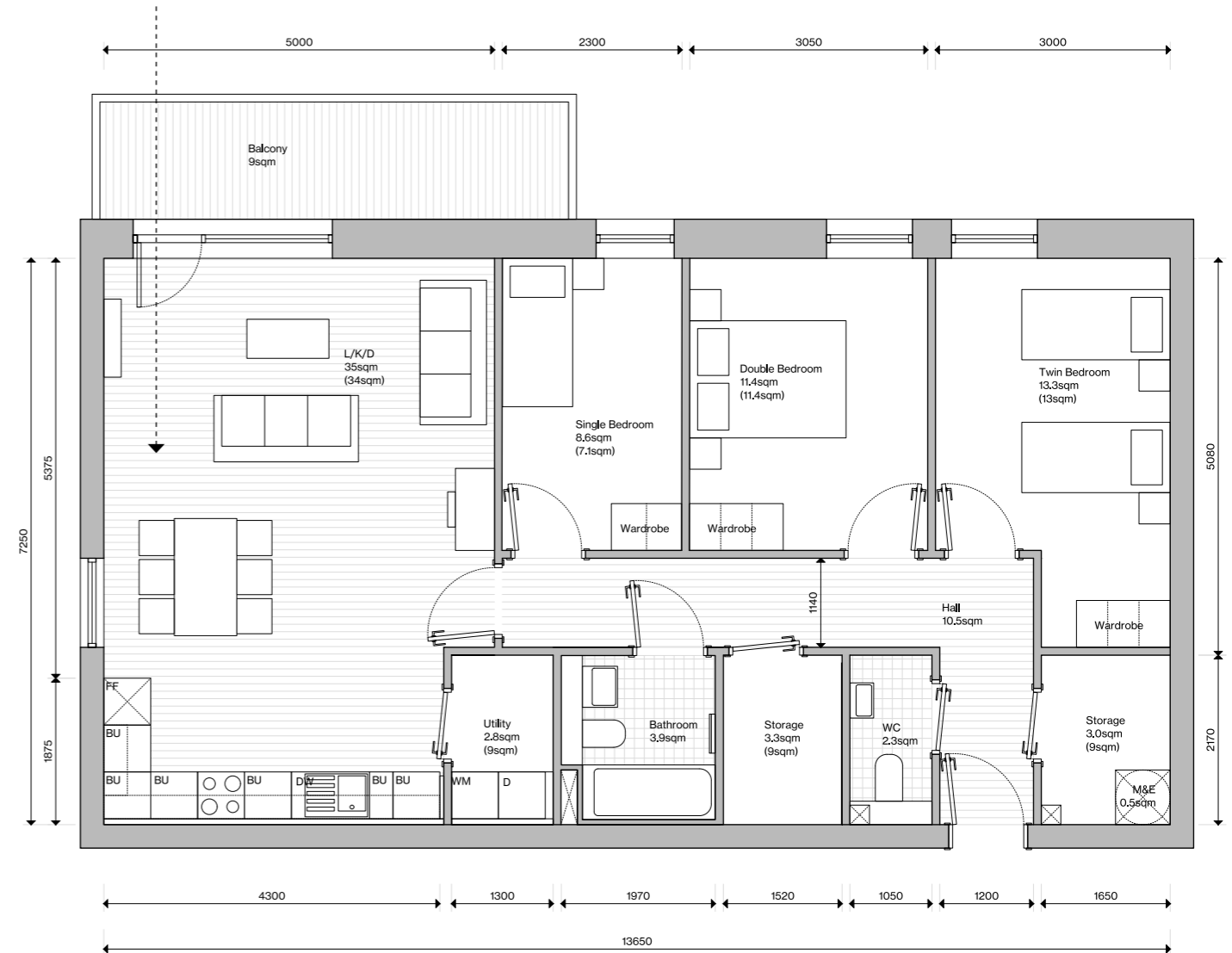

Section Two Building Design

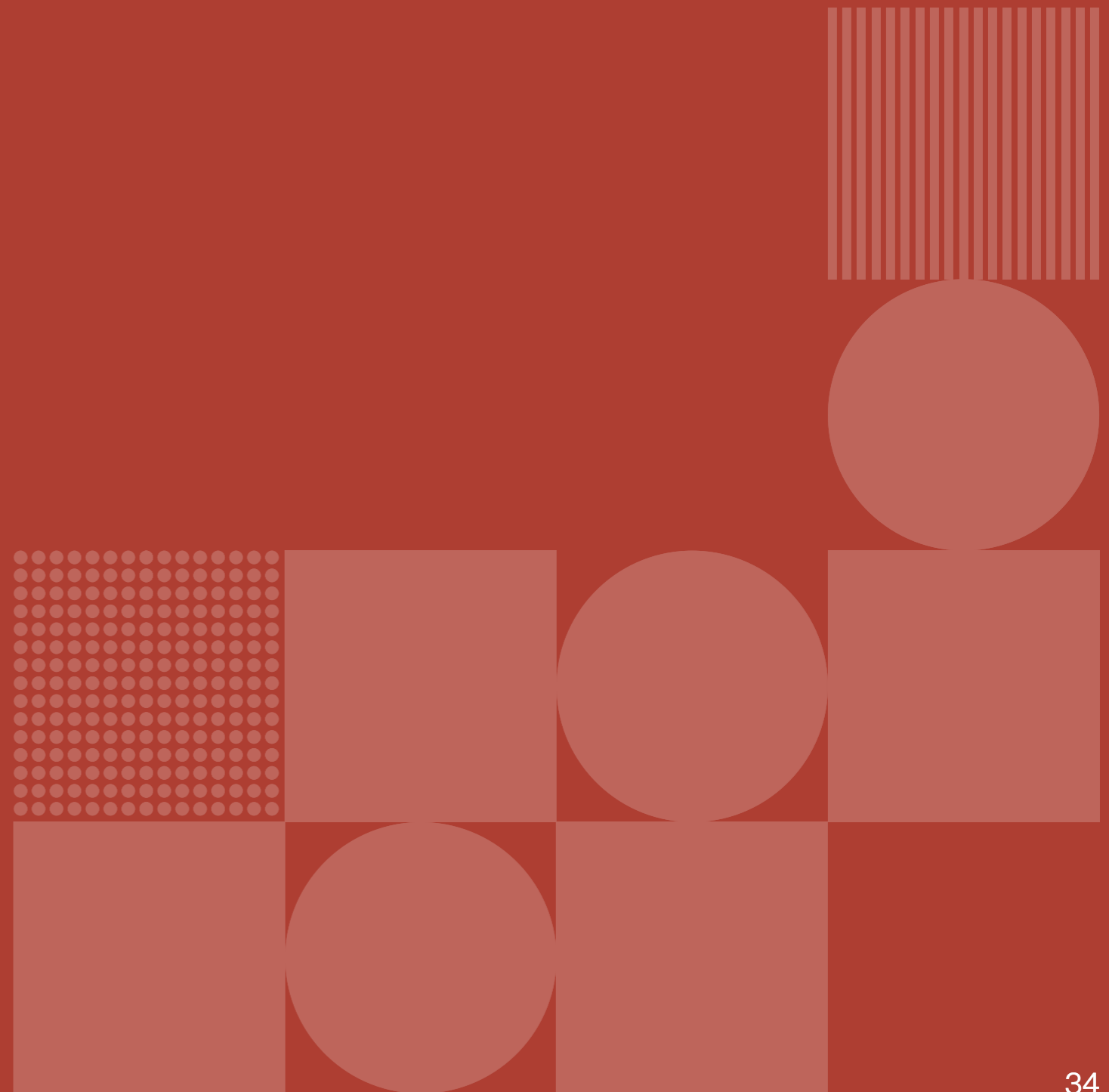

2.1

Building Layout

2.1.1 Design Principles

The layout of the building requires careful consideration to ensure efficient design that prioritises the provision of well designed apartments and good quality communal areas that foster a sense of community within the development. The building layout should be considered from the outset as part of the design response to the site context and proposed urban form. The following guidance should be considered when designing the building layout;

1. Building Typology

The predominant building typology should be based on a double loaded corridor with apartments accessed from both sides of the corridor. Building types should be standardised and repeated across the site as much as possible to minimise apartment types. The use of deck access typologies should be avoided.

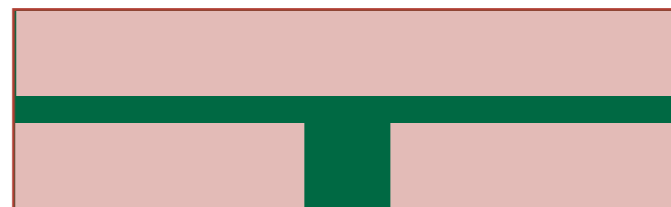

2. Building Depth

Careful consideration should be given to determine the appropriate building depth to ensure minimum apartment sizes can be achieved whilst maximising the efficient use of the site. Apartments should be well proportioned, with room depths informing the overall building depth. Due consideration should be given to achieving internal daylight requirements without the need for excessive glazing that can result in overheating issues.

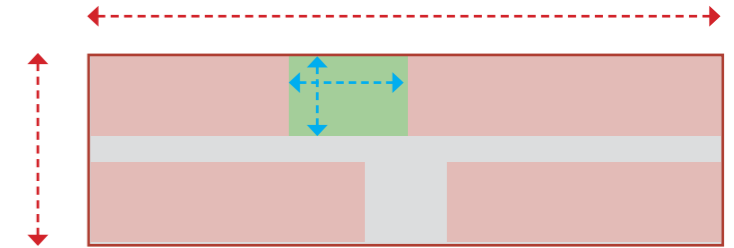

3. Corridor Design

Open ended corridors should be provided where possible, to provide natural daylight and ventilation to communal corridors, facilitate greater standardisation of apartment types and assist with site access during construction. Well designed corridors should encourage social interaction and foster a sense of community within a building.

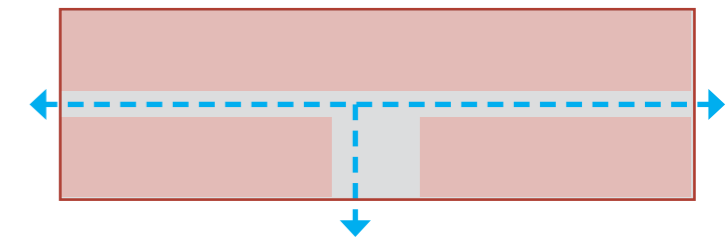

4. Fire Safety/Sprinklers

The building layout and arrangement of apartments should ensure the travel distances are achieved without the need for mechanical smoke extraction or secondary escape stairs. Natural smoke extraction is preferred to reduce ongoing maintenance costs, ideally with the use of opening vents at the ends of the corridors. Buildings of 8 units per core per floor and below should be designed not to rely on the use of sprinklers where as all buildings with more than 8 should be designed with sprinklers.

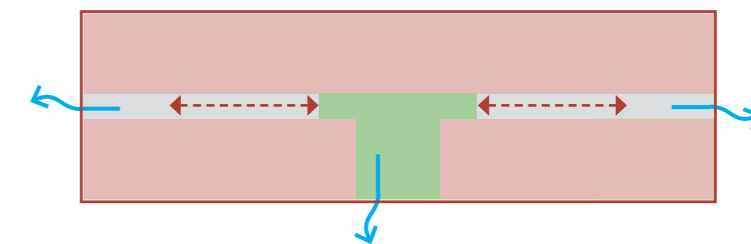

5. Apartments per Floor

Building layouts should maximise the number of apartments per core per floor. Ideally all apartment buildings should provide 12 apartments per core per floor subject to site constraints. Reducing the floor plates below 8 apartments should be avoided.

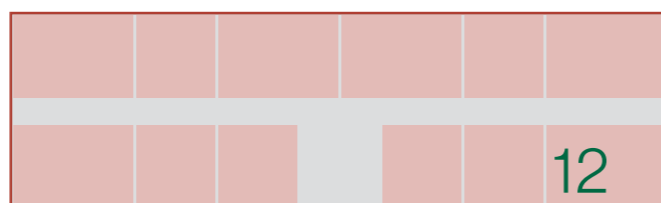

6. Apartment Standardisation & Stacking

Building layouts should allow for apartment types to be repeated across a floor plate to minimise apartment types. Standard apartment types should be used across a project site. 10% overs, UDH and corner variations should be aligned where possible to minimise the number of variations required. Apartments should be stacked from ground to top floor and any upper floor setbacks should align with apartment stacking to avoid creating additional apartment types.

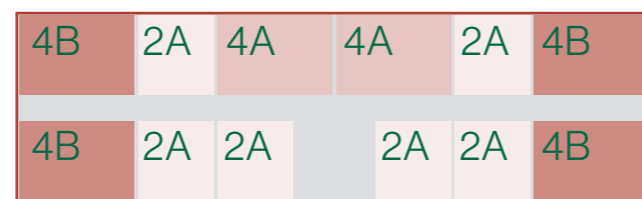

7. Approach to Balconies

Projecting balconies should be used in lieu of recessed balconies where possible. The use of recessed balconies should be limited. Balcony types should be standardised across buildings and the site to facilitate off-site fabrication.

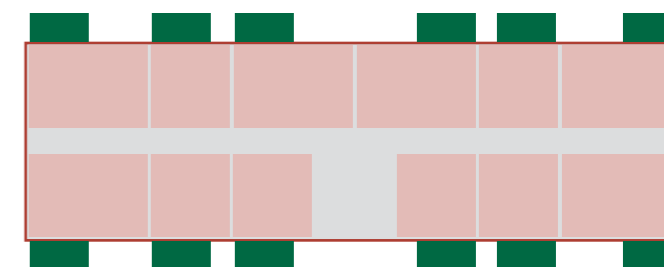

8. Dual Aspect

The appropriate level of dual aspect for the site should be determined by the design team at the outset based on the relevant planning requirement. A dual aspect strategy should be developed from the outset that facilitates the standardisation of apartment types and minimises the need for special dual aspect apartment types. Prioritise making 3B5P homes and 2B4P homes dual aspect.

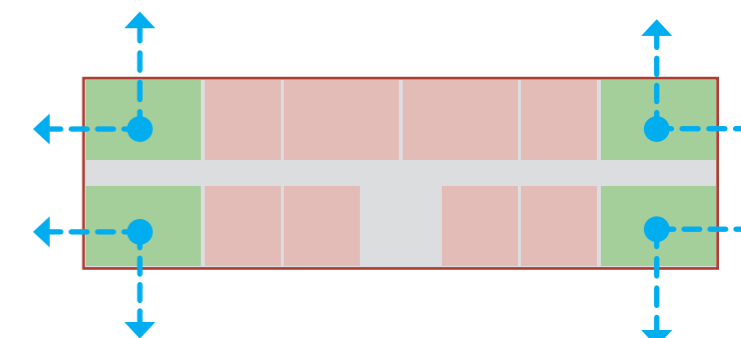

2.1.2 Approach to 10% Overs

Careful consideration should be given to how best provide the 10% over apartments within the agreed mix.

To minimise the increase in the overall building area, identify the apartment types that benefit most from the additional area and limit the number of variations required. Ideally, the smaller apartment types such as the 1B2P and 2B3P would be oversized, as they tend to benefit most from the additional area and have the least impact on the building area.

Oversized apartments should double up as UDH and/or corner variations as required. It is not necessary to provide both minimum and oversized variations of each apartment type.

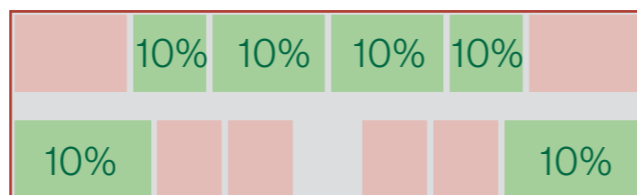

Type	Variant
Studio	Standard
1B2P	10% Over
2B3P	10% Over
2B4P	Standard
3B5P	10% Over



Type	Variant
Studio	Standard
1B2P	Standard
1B2P	10% Over
2B3P	Standard
2B3P	10% Over
2B4P	Standard
2B4P	10% Over
3B5P	Standard
3B5P	10% Over

2.1.3 Approach to Mix

Consideration should be given to how the required mix can be best achieved on a project at an early stage.

It is not necessarily required for the mix to be achieved in each building on a project and may be more efficient if the mix is achieved across the site as a whole. That said, each building should accommodate a mix of households and buildings containing one type of household should be avoided.

On sites that include lower density building typologies such as suburban sites, consideration should be given

to locating the larger unit types, such as the 3B5P homes in the lower density buildings and providing the smaller unit types in the apartment buildings.

The unit mix will be determined on a project by project basis. Refer to the project Development Brief for the required mix. The drawings below illustrate how some typical mixes can be achieved using the LDA apartment types from section 1.

Scenario 1 - Urban Site

Mix achieved in one building

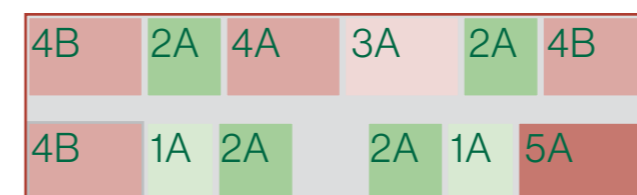

Studio	16.7%
1B2P	33.3%
2B3P	8.3%
2B4P	33.3%
3B5P	8.3%

Scenario 2 - Urban Site

Mix achieved across two buildings

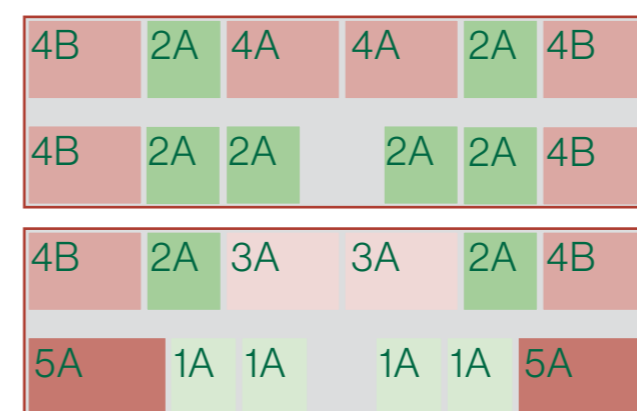

Studio	16.7%
1B2P	33.3%
2B3P	8.3%
2B4P	33.3%
3B5P	8.3%

Scenario 3 - Suburban Site

Mix achieved in one building

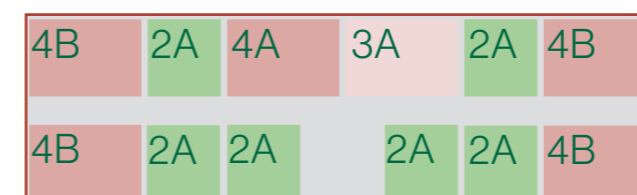

Studio	0%
1B2P	50%
2B3P	8.3%
2B4P	41.7%
3B5P	0%

2.1.4 Flexibility in Building Layout

The LDA typical apartment types can be configured in a number of ways. The most appropriate building layout should be determined on a project by project basis, based on the site context, dual aspect requirement and proposed urban design.

The simplest building layout possible should be used. That said a small number of simple apartment buildings, combined with smaller enclosing structures could be configured to create a complex and rich urban environment. The drawings that follow illustrate a number of ways in which the LDA typical apartment types can be configured.

Staggered Building

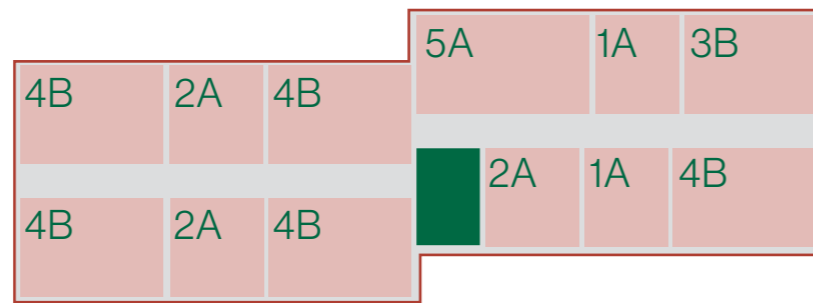

Inset Building

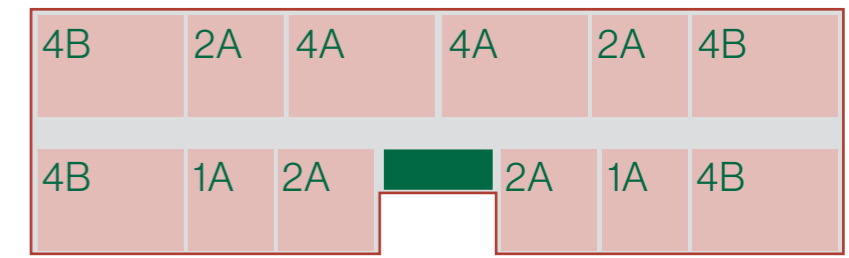

Stepped Corners

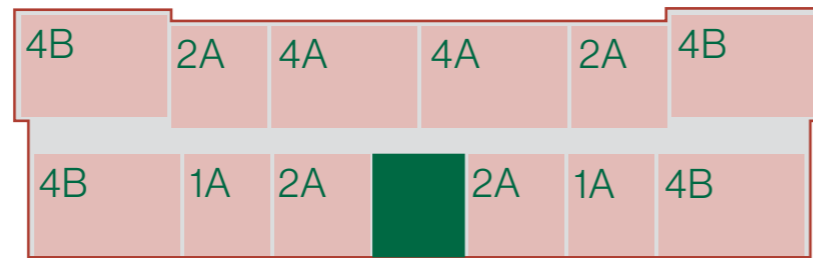

L-shaped Building

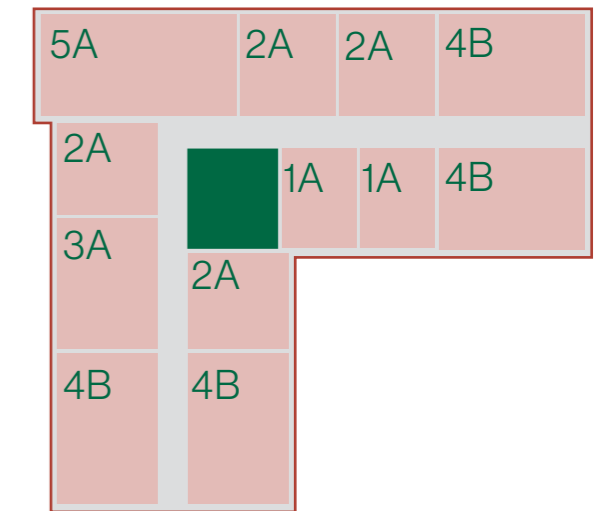

Straight Building

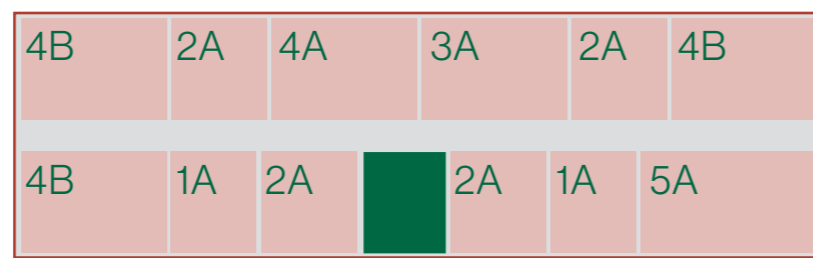

2.2

Building Form

2.2.1 Massing

1. Simple Form

Building form should be simple and orthogonal, avoiding curved, angular or complex forms. Recesses, overhangs and steps in the building envelope should be kept to a minimum. Upper floor set backs should be avoided. Where setbacks cannot be avoided they should be aligned with structural grid to avoid costly transfers structures.

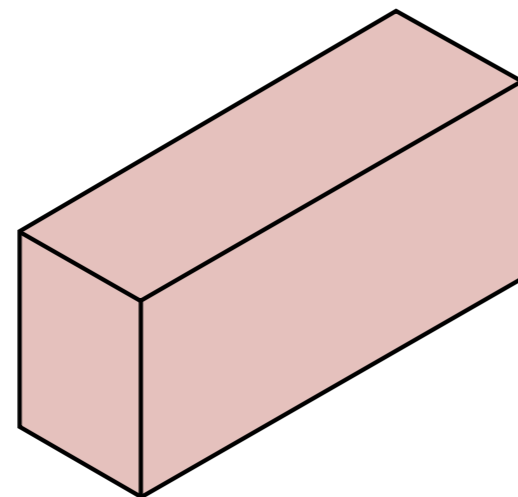

2. Building Height

Consideration should be given to determining the most appropriate scale and massing to achieve the required density while maximising the delivery of affordable homes. Bearing in mind construction costs increase as building heights increase, careful consideration should be given to the trigger points for increased cost associated with building heights such as increased fire safety requirements, structural requirements and lift requirements.

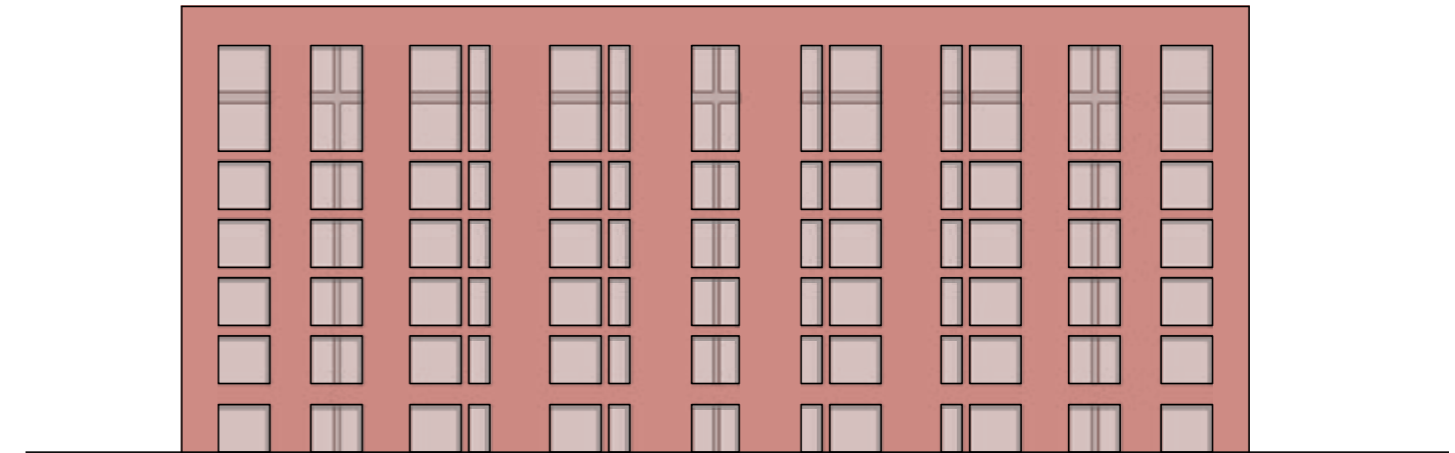
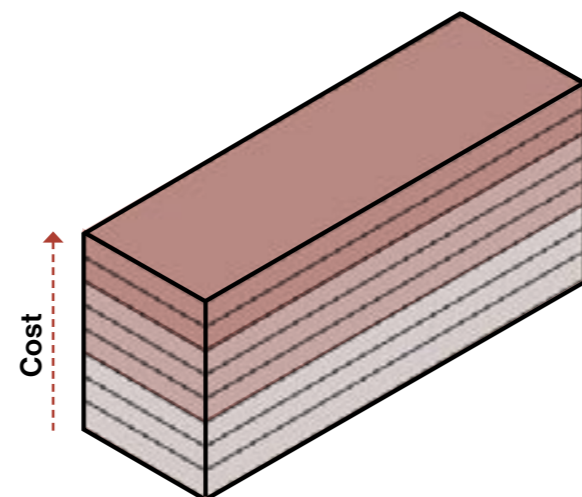

2.2.2 Facade Design

Façade design should provide a regular and simple façade composition of punched openings based on the apartment layouts. The placement of windows on the façade should consider the provision good daylight levels within the apartments, views out, privacy and the functionality of the apartment layout.

The following guidance should be considered when designing façades;

- Façade design should have a carefully composed and ordered fenestration pattern.
- Façade design should not compromise apartment layouts or add to the number of apartment types on a project.
- Number of materials used on a façade should be kept to a minimum.
- Brick should be the primary façade material in combination with more affordable materials.
- Use of colonnades or porticoes should be avoided.
- Large expanses of glazing or curtain walling should be avoided.
- Large projecting architectural features such pop-outs and bay windows should be avoided.
- Recessed balconies should be avoided where possible. When recessed balconies cannot be avoided consider alternatives to brick on balcony reveals.
- Double façades and secondary framed structures be avoided.
- Parapet heights should be minimized.
- Corner windows should be avoided.
- Proximity of substation to windows should be carefully considered to avoid the need for fire rated windows.
- Signage and louvre zones should be provided for all commercial units.

2.3

Building Efficiency

Buildings layouts should be designed from the outset with the LDA Key Performance Indicators (KPIs) in mind. The achievement of the KPIs should not compromise the apartment or building layout. Careful consideration should also be given to build-ability and construction efficiencies, in addition to spatial efficiencies. KPIs should be tracked throughout the design development of the project. For further detail on KPIs refer to the LDA Cost Estimate Document.

Note 1

It is acknowledged that an increase in the percentage of studios and 1 bedroom apartments will reduce Gross Internal Area (GIA) per unit whilst an increase in the percentage of 3 bedroom apartments will increase the GIA per unit. The efficiency analysis will be considered in the context of the mix. Below are some sample scenarios.

- Suburban Site: Based on a suburban mix with no 3 bedroom apartments and a net to gross in the range of 77 to 80% it is expected to target a GIA per unit (efficiency) range of 76m² to 82m² (subject to mix).
- Urban Site: Based on an urban mix including 3 bedroom apartments and a net to gross in the range of 77 to 80% it is expected to target a GIA per unit (efficiency) range of 76m² to 86m² (subject to mix).

Note 2

Up to and including Stage 1b it can be assumed the target apartment number excludes handed variations of types, however all handed types should be identified and drawn from Stage 2 onwards.

Note 3

The target for bathroom types includes a standard bathroom and UDH bathroom.

Up to and including Stage 1b it can be assumed the target bathroom number excludes handed variations of types, however all handed types should be identified and drawn from Stage 2 onwards.

Key Performance Indicators

Building Metric	Target	Notes
Average Gross Floor Area per apartment	76-86sqm	See note 01
Net Area over minimum required area	105-107%	
Net to Gross Area	80%	Typical upper floor
	77%	All floors combined
Wall to Floor Ratio	60%	
Average Area of Facade per apartment	52sqm	
Glazed to solid ratio	35%	
Apartments per core	12	Average per floor per block
Floor to floor height	3.075m	Typical upper floor
Floor to ceiling height	2.5m	
Average Balcony Area	6sqm	

Planning		
Dual aspect	33-50%	Project Specific
10% Overs	51%	

Standardisation		
Apartment Types	10-12	See note 02
Bathroom Types	2	See note 03
Balcony Types	3-5	
Window Types	10-15	

2.4

Worked Example

The following section demonstrates how the LDA building guidance set out earlier in section 2 can be achieved utilising the typical apartment types set out in section 1 of this document. The example shown is based on an indicative unit mix. For project specific unit mix refer to the Development Brief. The mix has been achieved across two typical blocks to assist in the rationalisation of the blocks. Open plan variations are used within the centre of the building with corridor variations used on the corners to achieve travel distances.

Mix	Required	Block 01 Provided	Block 02 Provided	Combined Provided
Studio	15%	33.3%	0.0%	16.7%
1B2P	35%	16.7%	50.0%	33.3%
2B3P	10%	0.0%	16.7%	8.3%
2B4P	33%	33.3%	33.3%	33.3%
3B5P	7%	16.7%	0.0%	8.3%

Building Metrics	Required.	Provided	Provided	Provided
Average Gross Floor Area per apartment	76-86	80.1	78.5	79.3
Net Area over minimum required area	105-107%	106%	108%	107%
Net to Gross Area	80%	79%	79%	79%
Wall to Floor Ratio	60%	49%	49%	49%
Average Area of Facade per apartment	52sqm	N/A	N/A	N/A
Apartments per core	12	12	12	12
Average Balcony Area	6sqm	6.3	6.0	6.2

Planning	Required	Provided	Provided	Provided
Dual Aspect	33-50%	33%	33%	33%
10% Overs	51%	33%	67%	50%

Standardisation	Required	Provided	Provided	Provided
Apartment Types	10-12	5	3	6
Bathroom Types	2	1	1	1
Balcony Types	3-5	3	3	3

■ Studio
 ■ 1B2P (10% Over)
 ■ 2B3P (10% Over)
 ■ 2B4P (Open)
 ■ 2B4P (Corr)
 ■ 3B5P (10% Over)



2.5

Communal Areas

Well designed communal areas should create opportunities for social interaction and help foster a sense of community among residents. The design of communal facilities such as bike stores, bin stores and communal open space needs careful consideration to encourage a sense of ownership and passive surveillance. Designers should consider both residents' and visitors' practical experience of using the building on a daily basis such as the residents' route from pavement to one's own door or residents' route from one's home to the bin stores on their way out.

2.5.1 Communal Entrance

The design of communal entrances should consider the legibility, security and accessibility for residents and visitors of the building. The design of the communal entrances is critical to the identity and place-making of a neighbourhood.

- All buildings should have one main entrance that is clearly identifiable, easily located and accessed from the public realm. Multiple building entrances should be avoided.
- The entrance area should be single height and naturally lit with glazing within or adjacent to the entrance door.
- A covered area should be provided at the main entrance door.
- Post boxes should be provided within the entrance area.
- All meters to be contained within secure cupboards.
- Where access to the communal courtyard is provided on the same levels as the main entrance, a visual connection through to communal area should be provided.
- Consideration should be given to how delivery services will locate and access the main entrance.
- Parcel storage should be provided within a centralised parcel locker facility within the development.
- A cleaner's store and WC should be provided within or in close proximity to the main entrance.
- In a developments of over 300 homes, a management office of approximately 15sqm should be provided.
- The privacy of apartments adjacent to main entrance should be considered.
- Facilities for a concierge are not required.
- Access control should be integrated into the design of the main entrance door.

Illustrative Entrance Layout

Lift

Landlords meters

Entrance mat

Access Control

Postboxes

Covered Entrance

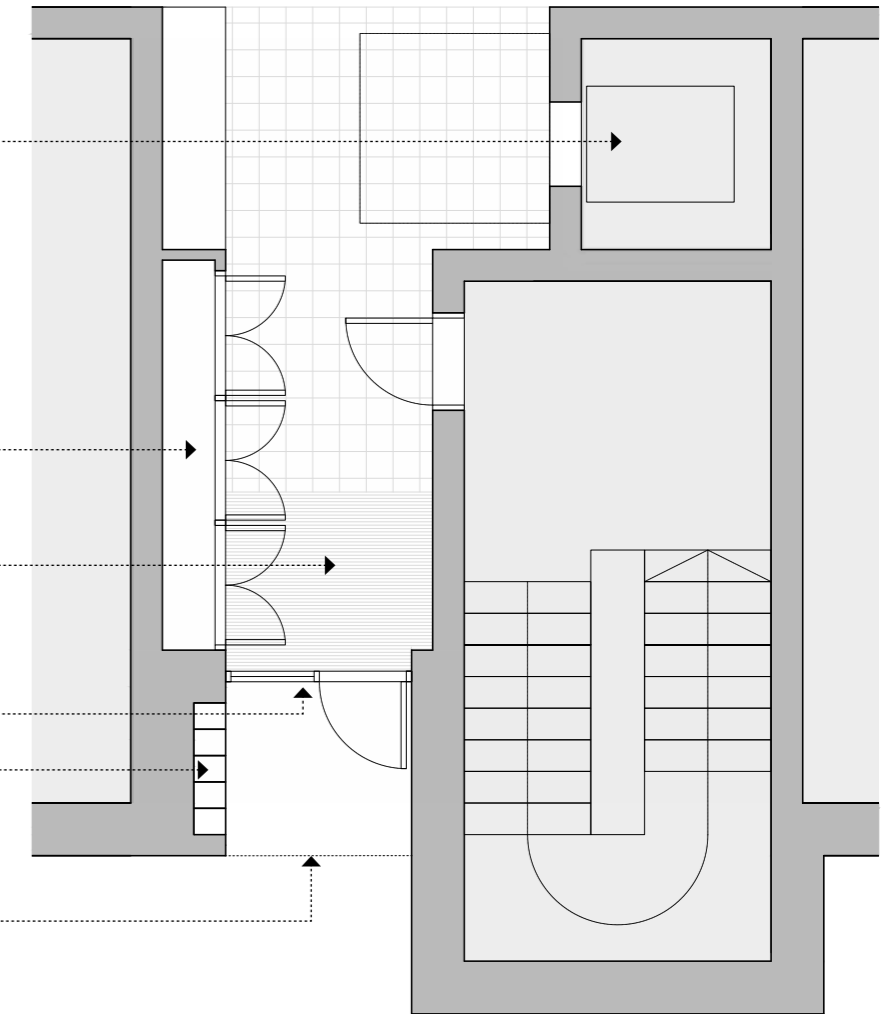

2.5.2 Communal Corridors, Stairs & Lifts

The following guidance should be considered when designing the layout of the communal stairs and lifts;

- The layout of the stairs and cores should be designed to be as compact as possible while complying with all relevant requirements.
- Stairs and lift lobbies should be naturally lit where possible.
- The design of the core should consider the ground floor entrance layout and any access requirements to communal open spaces.
- One 13 person passenger lift is to be provided unless the lift traffic analysis requires more.
- Lift shafts should be sized to suit a number of lift suppliers.
- Communal corridors should be a minimum of 1500mm wide. Localised narrowing is acceptable where required. Provision of 1800mm wide corridor may be considered where construction efficiency and apartment standardization justifies the use of a wider corridor.

2.6

Communal Storage

The design of the communal areas should encourage and prioritise pedestrian and cycling through the site. The storage strategy should avoid locating bin, bike and car storage in areas that could be otherwise used as residential accommodation. Bin and bike stores can be used as enclosing elements to demarcate communal open space. Consideration should be given to clustering of communal facilities to increase social interaction.

2.6.1 Bike Storage

The design of bikes stores should encourage cycling as a sustainable mode of transport by offering a secure and easy to use bike storage in close proximity to residential entrances.

The following guidance should be considered when developing the bike storage strategy;

- Residential bike storage (long stay) to be provided within standalone, secure and unheated building/s where possible.
- Bike storage rooms should ideally contain no more than 75 bikes spaces.
- Residential bike storage should be overlooked by active uses.
- Residential bike storage to use double stackers to minimise area required. Stands to allow a bike frame and wheel to be securely locked. Spacing of stackers to be as per manufacturer's recommendations. Portion of Sheffield style stands to be provided for non-standard and cargo bikes.
- Visitor bike storage (short stay) to be located in public realm, utilising simple Sheffield style stands.
- Inclusion of bike storage within the building footprint should be minimised.
- Bike stores should all be provided with a gulley and bib tap for washing down.

Bike and Bin store in stand alone structures with on street car storage

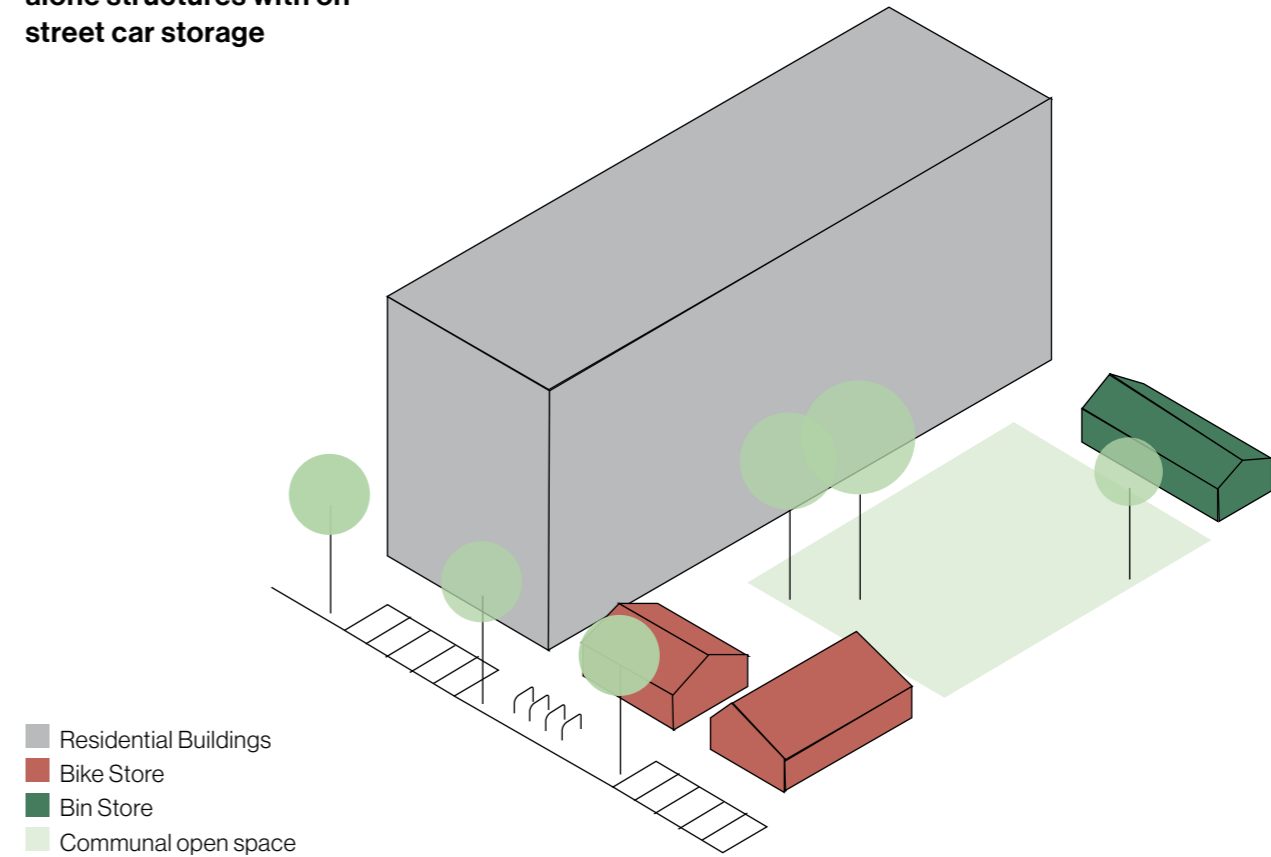

2.6.2 Bin Storage

The following guidance should be considered when developing the bin storage strategy;

- Provide appropriately sized storage area to satisfy the three-bin system for the separate collection of mixed dry, organic waste and general waste.
- Bin storage to be provided within standalone, secure, naturally ventilated and unheated building/s. All bin stores should include a roof. Inclusion of bin storage within the building footprint should be minimised. If it cannot be avoided the bin store should be accessed externally to avoid the need for a ventilated lobby
- Access to bins should be restricted to residents, building management and waste collection operatives.
- Bin stores should be located to be easily accessible to residents.
- Bin stores should be located to avoid the need for building management to move bins from bin stores to a temporary holding area for collection. If this cannot be avoided and the waste management strategy relies on building management in this way, the design team should seek approval from the LDA.
- Bin stores should all be provided with a gulley and bib tap for washing down.

2.6.3 Car Storage

The design of the masterplan and public realm should facilitate and encourage pedestrian and cycle mobility throughout the site and connection to wider infrastructure including public transport options at site edges. Reduced need for private car ownership should be reflected in reduced car storage provision.

The following guidance should be considered when developing the car storage strategy.

- Extent of car storage should be minimised.
- Car Storage should be provided on grade and be sensitively integrated into the public realm.
- If car storage cannot be accommodated at grade then podium car parking should be provided. See specific guidance on podium car storage below.
- Basement car storage must not be provided as it is not compatible with the delivery of affordable and sustainable homes.
- The distribution of car storage should broadly align with the homes which they are intended to serve to ensure that appropriate parking provision can be delivered on a phased basis consistent with the overall phasing of the project.
- Consideration should be given to the provision and appropriate location of accessible car storage.
- Consider the inclusion of car sharing.
- Extent of EV charge points to be as per relevant requirements.

In the event that podium car storage cannot be avoided the following guidance should be considered.

- The setting out of the buildings at the outset of the project should be informed by standard car parking setting out requirements.
- Car storage should be located under the building above to minimise the overall size of the podium and avoid creating excessive uninhabitable space around the perimeter of the car store.
- Where the creation of uninhabitable space is unavoidable it should be used for bin storage, bike storage or plant.
- The layout should be carefully coordinated with the residential layouts above to minimise the need for transfer structure. Where transfer structures are required the design team should seek approval from the LDA
- Car storage should be naturally ventilated and avoid the use of impulse fans.
- Early consultation with a fire consultant is advised to determine the requirement for sprinklers.
- Vehicle tracking should be carried out to ensure the functionality of the car park.

Hierarchy of Car Storage

1. Minimise car storage.
2. Provide car storage on grade.
3. Provide car storage within podium.

Illustrative Section

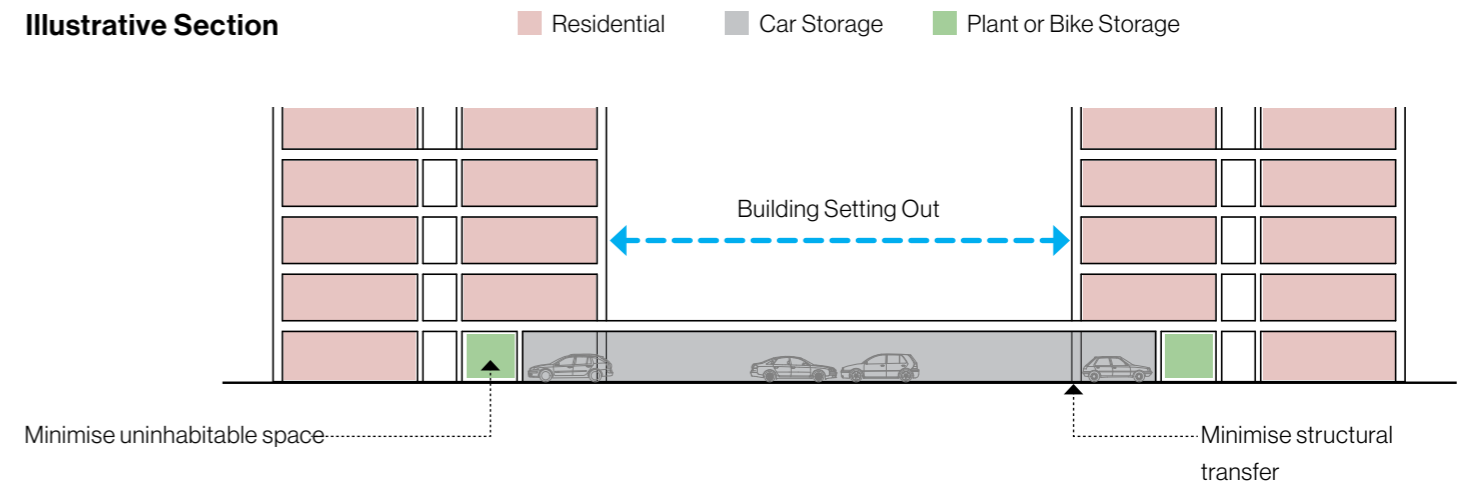

Illustrative Plan

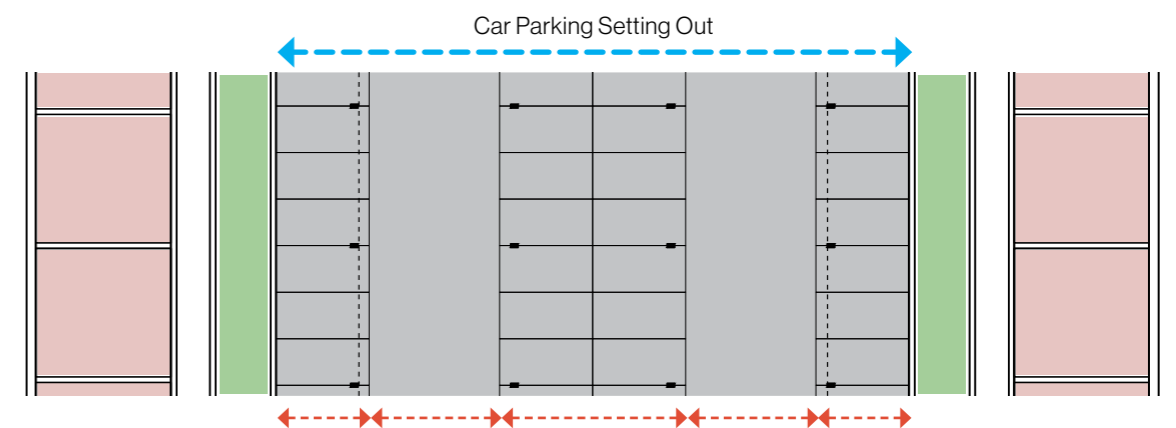

Section Three Technical Considerations

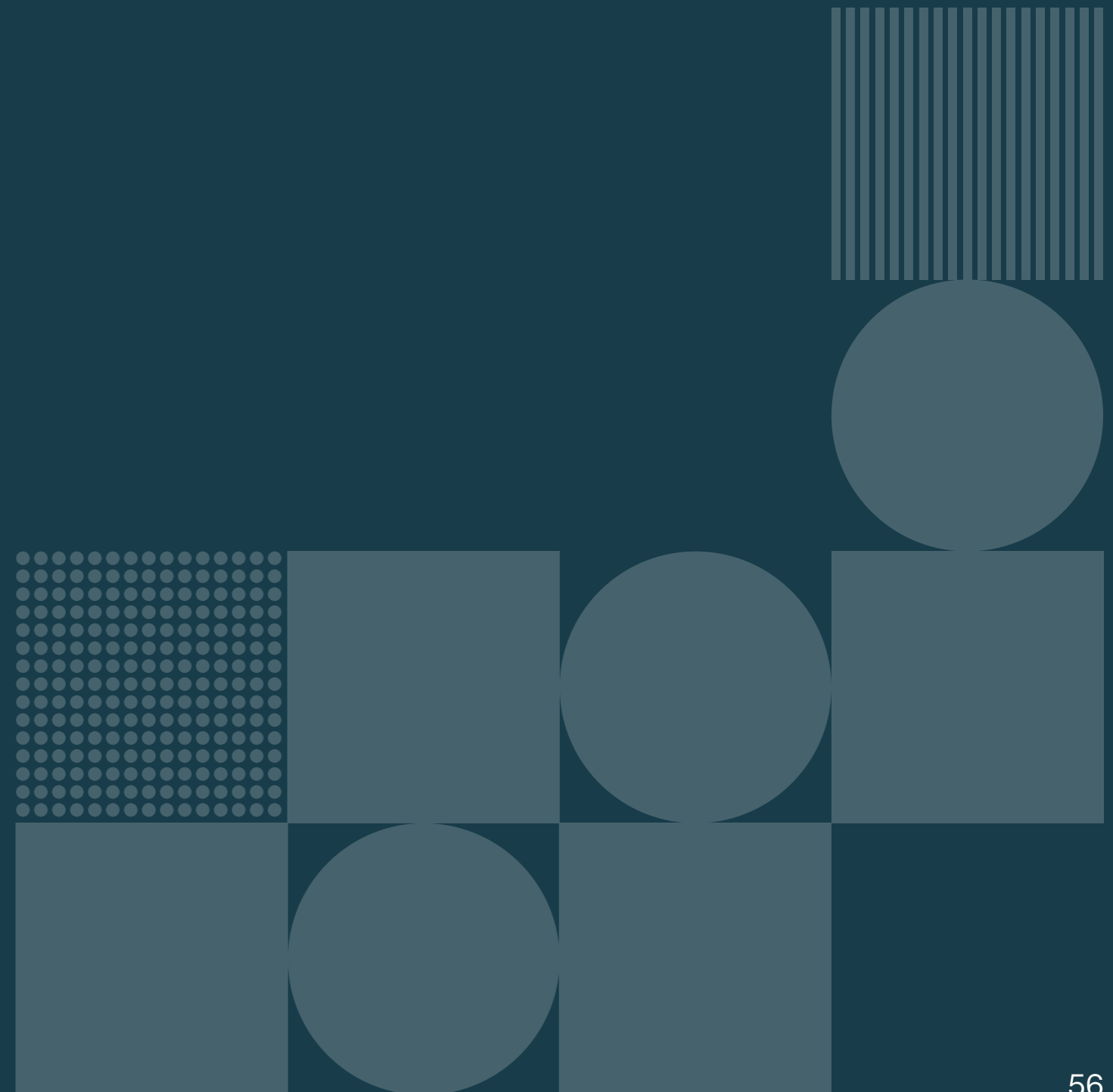

3.1

Architecture

3.1.1 Facade Detailing

Façade detailing should be simple, robust and stand the test of time. Consideration should be given to affordability, build-ability, on-going maintenance and endurance of the façade.

The following guidance should be considered when detailing façades;

- Brick detailing should be simple, cost effective and build-able. Hand laid brick, utilising stretcher brick bond with standard mortar to be used throughout.
- All brick façades to be designed to brick dimensions.
- The Design Team should consider various external wall build ups to determine the most appropriate method of construction on a project-by-project basis.
- Consider the integration of intake and extract vents into the façade.
- Robust and easily maintained materials should be used in high traffic areas.
- All renders should be through colour render, preferably with masonry substrate.
- External wall insulation systems should be avoided.
- Facade to be carefully detailed to shed water, avoid staining and reduce ongoing maintenance.
- Rainwater drainage to be considered at stage 2a and shown on all elevations.
- Movement joints to be considered at stage 2a and shown on all elevations.
- Glazed canopies should be avoided.

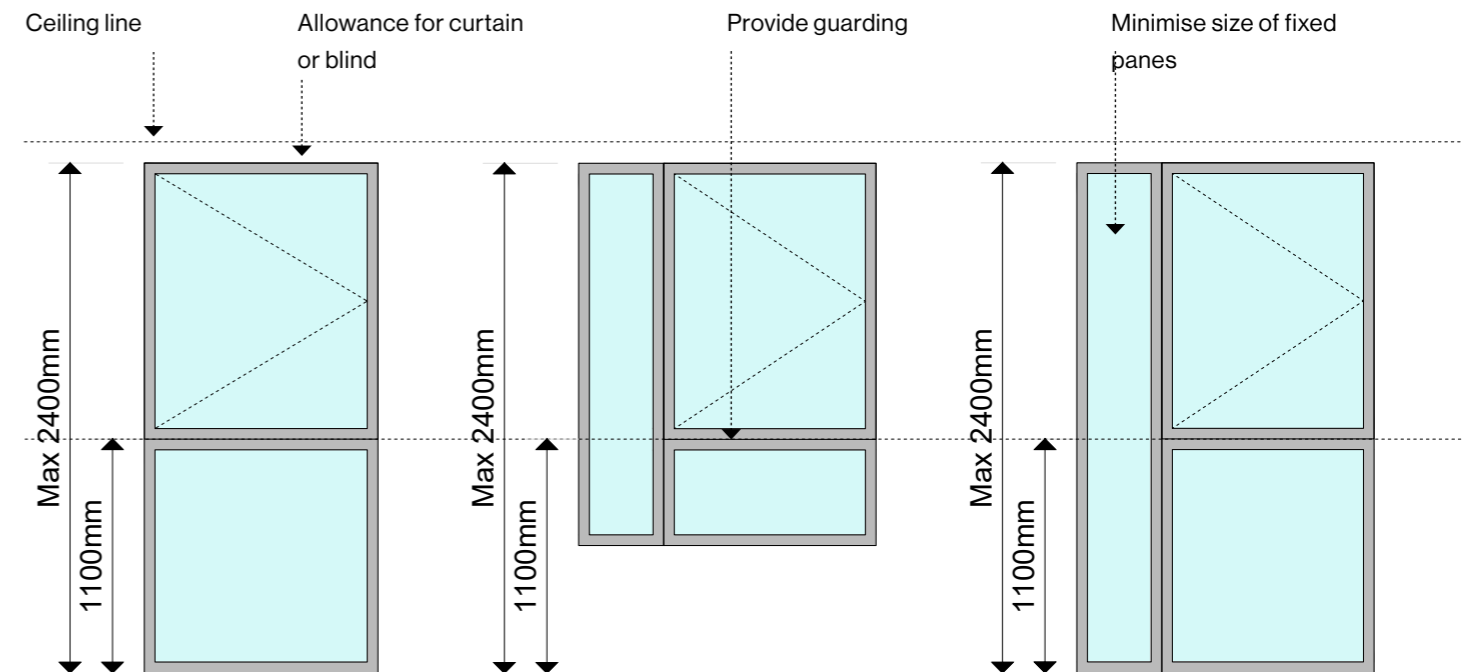

3.1.2 Window Detailing

Window design needs to be carefully considered to ensure an appropriate balance is achieved between the various requirements such as daylighting, overheating and cleaning.

The following guidance should be considered when designing windows/doors;

- Windows/doors sizes should be standardised across an entire scheme and number of variations should be minimised.
- Windows/doors should be designed to align with industry standards and avoid non-standard sizes that limit availability in the market.
- Curtain walling should be avoided in all residential areas.
- All balcony doors to be side hung inward opening doors.
- Consideration should be given to how curtains and/or blinds could be fitted to all openings.
- Safety restrictors should be provided on all windows.
- All window openings to be above 1100mm.
- All windows/doors should be designed to be cleaned safely from inside by residents, whilst taking into account a risk assessment to the recommendations of BS 8213-1:2004
- All windows/doors should be designed to allow for internal glass replacement. Consideration should be given to how large glazing units can be brought through a building, such as limitations on lift sizes etc.
- A cleaning and maintenance strategy should be developed prior to the submission of planning.

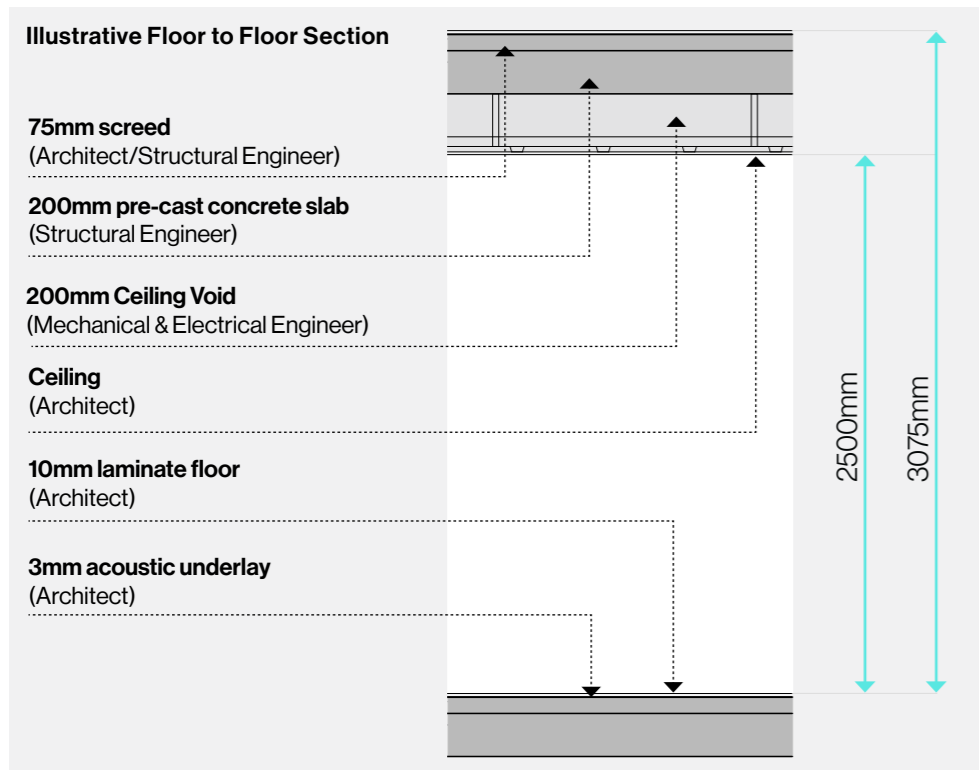

3.1.3 Floor to Floor

The floor to floor height should be established at the outset of the project.

The following guidance should be considered when establishing the typical upper floor to floor height;

- The floor to floor should be coordinated with all key disciplines in the design team.
- The floor to floor height should be minimised, and aim to be no more than 3075mm on the upper floors.
- The floor to ceiling height should be maximised, and aim to be no less than 2500mm on the upper floors.
- The floor to floor height should be based on brick dimensions.
- Consideration should be given to how level access showers will be provided in UDH and UDH+ apartments.
- Bulkheads should be avoided. Where bulkheads cannot be avoided, their alignment should be carefully considered.
- Lower floor to ceiling heights may be considered in bathrooms, halls, stores and utility rooms.
- Consideration should be given to the coordination of bathroom pods with the typical floor to floor to ensure level access to the bathroom can be achieved.
- Consideration should be given to construction tolerances.

3.1.4 Typical Build Ups

Typical build ups should be considered at the outset of a project to inform the setting out of apartments and buildings.

The following guidance should be considered when setting out typical build up;

- All build ups to comply with Building Regulations.
- All typical floor build ups should be considered including as a minimum ground floor and typical upper floor.
- All roof build ups should be considered including any roof terraces.
- All external wall build ups should be considered.
- All internal wall build ups should be considered including as a minimum party walls between apartments, party walls between apartments and communal corridors and party walls between apartments and cores.
- The integration of structure into internal walls should be carefully considered.
- An allowance for sockets and switches on party walls should be considered if required.
- Interfaces with podiums and/or roof terraces should be carefully considered.
- The impact of brick detailing such as recesses on the facade on the external wall build ups should be carefully considered.
- The design of external wall build ups should consider required u-value, insulation type and length of brick angle bracket.

3.1.5 Balcony Detailing

Balcony detailing should be simple and standardised across a project.

The following guidance should be considered when designing balconies;

- Balconies should be designed to allow for off-site fabrication.
- Early engagement with balcony suppliers is recommended to maximise design efficiencies.
- Bolt-on balcony construction is preferred.
- Consideration should be given to the drainage of balconies.
- Consideration should be given to the connection detail.
- Consideration should be given to providing level access to balconies in Universal Design apartments.
- Glazed balustrades should be avoided.
- Waterproofing at the balcony door should be carefully considered to ensure an adequate upstand is provided between the waterproofing line to the door threshold, ideally 150mm upstand should be provided.

3.2

Structure

Design Teams should determine the most appropriate structural solution on project-by-project basis in terms of cost, programme and supply chain. At a minimum, teams should consider both pre-cast concrete wall and slab option and insitu concrete frame option. The analysis of these options should be carried out prior to the submission for planning.

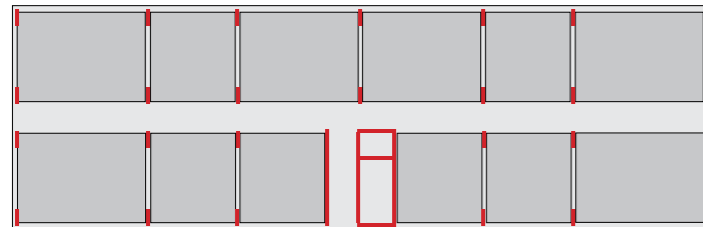

Insitu Frame

Consideration should be given to the requirement for internal partitions, internal lining, mitigation of cold bridging, incorporation of structure within apartment layouts, requirements for secondary steel and requirements for transfer structure at lower levels for each option. The following guidance should be considered when developing the structural strategy.

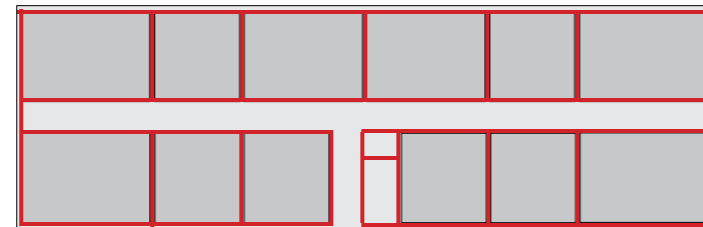

Pre-cast Wall and Slabs

- Structure should run continuously from roof to ground and transfer structures should be avoided. Where ground floor uses differ from upper floor uses the extent of structural transfer should be minimised through careful design coordination. The inclusion of all transfer structures should be brought to the attention of the LDA.
- When considering pre-cast wall and slab option, consideration should be given to using a twin wall system with cast in sockets and switches and painted concrete finish internally in appropriate areas.
- Structural design to avoid edge beams, down-stands and up-stands.
- Structural design to avoid steps and recesses in slabs.
- Structural design to make an allowance for additional weight associated with the use of bathroom pods.

3.3

M&E

The design team should consider the most appropriate heating and ventilation system to achieve NZEB compliance at the outset of the project. Design teams should consider central heating systems (district) and individual apartment heating systems. The different options should be considered in terms of energy efficiency, capital cost, operational cost and maintenance requirements.

Heating & Ventilation Systems

The following guidance should be considered when developing the heating system design.

- All options consider must comply with Building Regulations and any other relevant requirements.
- Consider the capital and operational cost.
- Consider the maintenance, redundancy, and plant replacement requirements.
- Consider the spatial requirements of each option including space required in individual apartments, ceiling void requirements, riser requirements, plant room requirements, roof level plant requirements and site wide distribution requirements.
- Consider system availability in the marketplace.
- Consider noise of heating system and any resultant acoustic attenuation requirement.
- Ventilation and hot water strategy should be considered in parallel with the heating system.
- The use of fossil fuels should be avoided if possible.
- Consider the management and maintenance requirements associated with all systems and

ensure reactive maintenance is readily available within Ireland, for all systems specified.

- Consider the options in the context of the project phasing.
- Consider any requirements to connect to local district heating systems either now or in the future.
- Radiators are to be provided in lieu of under floor heating.

Substation

The substation requirement should be assessed in stage 1a to ensure the most efficient distribution of substations is determined based on the requirements of the ESB. Placement of substations within residential buildings should be carefully considered to ensure the design of adjacent apartments complies with all relevant requirements. Engagement with the ESB should be carried out as early as is practically possible.

Section Four Outline Specification

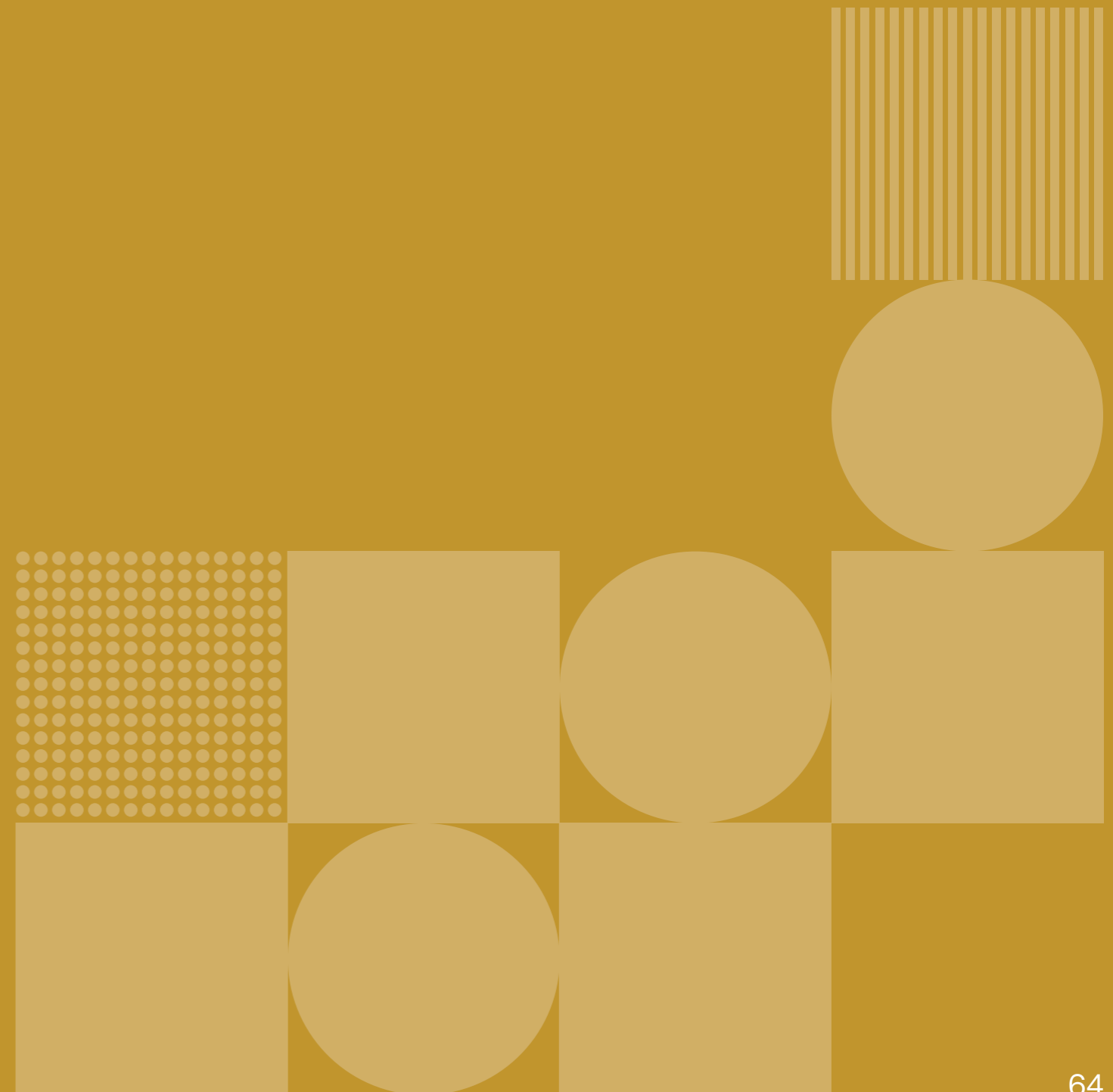

4.1

Apartments

The internal specification for all LDA homes needs to be good quality, robust and easily maintained with replacements readily available in Ireland.

The following specification has been informed by functionality, comfort and detailed upfront and lifecycle cost analysis.

The interior design of all LDA homes should be developed on a project-by-project basis, based on specification below. All finishes and colours should be selected to create a contemporary, timeless, and neutral palette, that residents can personalise and embellish with furniture and belongings.

The following specification applies to all LDA standard apartments and will ensure a consistent level of quality across all LDA projects. The specification of apartments designed to meet UDH requirements may differ.

Internal Finishes

Partition Walls	Partitions should be designed and constructed to achieve the required fire and acoustic rating. Where not needed to meet such performance requirements, internal partition walls are to be uninsulated timber or metal stud system partitions, generally with 12.5mm plasterboard each side or equivalent. Moisture resistant plasterboard to be provided in all bathrooms.
Party Walls	Party walls should be designed and constructed to achieve the required fire and acoustic rating. Where pre-cast concrete walls are not used, party walls to be timber or metal stud system partitions, generally with 12.5mm plasterboard each side or equivalent. Where party walls are pre-cast concrete walls with a fine finish, a skimmed and painted finish is acceptable, where a fine finish is not provided the wall should be lined with timber or metal stud system, generally with 12.5mm plasterboard or equivalent.
Ceilings	Ceilings should be monolithic suspended ceiling system with plasterboard finish to achieve the required performance, with metal access hatches provided where required, suitably positioned for ease of maintenance. Moisture resistant plasterboard to be provided in all bathrooms.
Flooring	8-10mm timber laminate flooring that is water resistant for up to 24 hours, with acoustic underlay. Laminate flooring to be included in kitchen, living room, bedrooms, utility, storage rooms, and internal apartment corridors.
Blinds	Washable roller blinds with steel operating chain to be fitted to all windows. All chains to be installed to conform to EN16434:2014, EN16433:2014, EN13120:2009+A12014. All blinds are to be in standard off-white/ivory colour. Blackout blinds in all bedrooms in the same colour. All blinds to be straight finish.

Joinery

Apartment Entrance Door	44 mm thick solid core flush door, paint grade with factory primer and hardwood lipping to all sides. Selected colour.
Internal Doors	44 mm thick solid core flush door, paint grade with factory primer and hardwood lipping to all sides. Colour: White
Skirting Boards	100 x 19mm moisture resistant MDF square profile skirting.
Architrave	75 x 25mm moisture resistant MDF square profile architrave.
Window Boards	25mm moisture resistant MDF bull-nose profile window boards.

Ironmongery

Door Handles	Brushed stainless steel lever handle.
Door Locks	Brushed stainless steel thumb turn to bathroom/shower room.
Door Stops	All doors to be fitted with wall mounted door stops.
Door Closers	All door closers should be surface mounted brushed stainless steel.
Entrance Door	Entrance door to include brushed stainless steel mortice lock, door number, spyhole and door chain.

Painting

Walls & Ceilings	Two coats of vinyl matt emulsion in addition to a primer coat where required. Colour: White
Joinery	Two coats of satinwood in addition to a primer coat. Colour: White

Wardrobes

Carcass	MFC core board with white melamine finish with ABS lipping.
Interior	Each wardrobe should contain a 450 mm width of 6 adjustable shelves and two proprietary chromed steel hanging rails and brackets.
Doors	Laminate door with ABS lipping and brushed stainless steel d-handle. Selected neutral colour.

Kitchen

Splash-back	Stainless steel at back of hob.
Worktop	Laminated worktop required to comprise 28mm particle board with square edge and ABS lipping.
Upstand	100mm high upstand to match worktop.
Doors	Handle-less laminate door with ABS lipping.
Carcass	MFC core board with white melamine finish, ABS lipping and intermediate adjustable shelf.
Sink	Mid -range stainless steel single sink and draining board.
Tap	Chrome mixer tap mounted to sink.
Level of Appliance Integration	All appliances fully integrated except for microwave. Open shelf in overhead cabinet to be provided to house a free standing microwave.
Kitchen Fire Blanket	Wall mounted light-duty fire blanket, complying with IS 415:1988. Fire blanket should be 1.2m by 1.8m in size.

Appliances

Dishwasher	Fully integrated dishwasher with 12 place settings. Maximum noise level 49db(a)
Microwave	Free standing 30 Litre 900W Microwave.
Fridge-Freezer	Fully integrated 70:30 fridge freezer.
Cooker-hood	Fully integrated cooker hood with stainless steel finish. Maximum Noise Level 65db(a).
Oven & Grill	Fully integrated 65 Litre capacity fan oven with grill.
Hob	Ceramic hob with four cooking zones.

Bathroom	
Flooring	Selected slip resistant ceramic tile to full extent of floor. Approximate size 600 x 300mm.
Wall Tiling	Selected ceramic tile. Approximate size 600 x 300mm: <ul style="list-style-type: none"> <input type="checkbox"/> Tiling on all walls around the bath/shower area, full height for the perimeter of the area concerned. <input type="checkbox"/> Tiled splash backs above WHB should cover the width of the basin at a minimum height of 300mm.
Mirrored Cabinet	Mirrored cabinet. Approximate size 660mm x 450mm x 145mm
Shower/Bath Screen	Chrome plated hinged 6mm glass screen with safety glass in accordance with BS6262.
Bath	Acrylic moulded bath with slip resistant coating and acrylic bath panel.
Shower	Acrylic moulded slim-line raised shower tray with slip resistant coating.
Toilet	Wall mounted concealed cistern WC with soft close seat, cover and dual flush plate with chrome finish.
Washbasin	Wall hung semi-pedestal washbasin. Approximate size 450mm x 550mm.
Brassware	<ul style="list-style-type: none"> <input type="checkbox"/> Chrome plated thermostatic bath/shower mixer with wall mounted shower head. <input type="checkbox"/> Chrome plated thermostatic washbasin mixer. <input type="checkbox"/> Chrome plated bath waste, over flow and plug kit.
Towel Rail	Chrome plated heated towel radiator. Approximate size 400mm x 800mm.
Toilet roll holder	Chrome plated toilet roll holder.
Shelf	Reconstituted stone shelf over concealed cistern.
Tanking	Full height around bath/shower area and full extent of floor with 150mm upstand to all walls.
Note	If pod construction is used the specification should be optimized accordingly. For instance with pods it is often more economical to fully tile all walls within the pod.

Utility Room		
Worktop	Laminated worktop required to comprise 28mm particle board with square edge and ABS lipping.	
Washing Machine	Free standing 7kg Capacity Washing Machine	
Dryer	Free standing 7kg Capacity Dryer	
Stacking Kit	Stacking kit for washing machines and dryer where layout requires it	
M&E Cupboard	If M&E systems are located within a storage or utility room, they should be enclosed within a secure M&E cupboard.	
Electrical		
Power & Data	Moulded white plastic sockets and switches to relevant standards fitted throughout. All units to be wired for TV/broadband/telephone for minimum three providers. Isolation switches to include engraving identify relevant appliance.	
Smoke & Heat Detectors	Smoke and heat detectors to be provided in accordance with relevant standards.	
Carbon Monoxide Detector	Carbon monoxide detectors to be provided in accordance with relevant standards.	
Lighting	Energy efficient LED light fittings.	
Access & Security	Audio intercom in each apartment linked to main entrance door.	
Power & Data		
Room	Sockets	Lighting
Hall	1 double socket	Pendant light
Bedrooms	3 double sockets	Pendant light
Living Room	4 double sockets, 1 telephone connection, 1 cable TV connection and 1 fibre optic broadband connection.	Pendant light
Bathroom	n/a	3 Downlights with replaceable lamps and appropriate IP rating
Kitchen	3 double sockets and isolation switches as required	Pendant light
Utility Room	1 double socket	Surface mounted with appropriate IP rating
Balcony	n/a	Surface mounted with appropriate IP rating

4.2

Communal Areas

The internal specification of all communal areas within LDA apartment buildings should be highly durable to withstand the inevitable wear and tear these areas will be exposed as well as being easily maintained with replacements readily available in Ireland.

The interior design of communal areas should be developed on a project-by-project basis, based on specification below. The selection of finishes and colours within the communal areas of an individual building should create a sense of identity within a development to help foster a sense of community within that building.

Consideration should be given to the use of exposed finishes where appropriate. All signage and wayfinding should be considered as part of the interior design.

The following specification applies to all LDA standard apartment buildings. The specification of apartment buildings designed to meet UDH requirements may differ.

Entrance Lobby

Flooring	Selected large format porcelain tiles.
Ceiling	Plasterboard ceiling with access metal panels where required.
Lighting	Surface mounted lighting with motion sensor activation with variable time delay.
Power & Data	1 cleaner's socket.
Matwell	A mat should be provided that is at least as wide as the entrance door, 1.5m deep and is flush with the adjacent floor surface.
Letterboxes	The entrance area should contain secure, accessible and easily located letter boxes. The use of fire rated letter boxes should be avoided where possible.
Cleaners Cupboard	A dedicated lockable store for cleaning materials with a cleaners sink.

Corridors

Flooring	Selected carpet tiles.
Ceiling	Plasterboard ceiling to meet acoustic requirement with metal access hatches provided where required, suitably positioned for ease of maintenance.
Lighting	Surface mounted lighting with motion sensor activation with variable time delay.
Power & Data	Cleaner's sockets. Number as required for cleaning.

Stairs

Flooring	Selected carpet tiles with nosing trim or exposed finishes where suitable.
Wall	Plasterboard lining to meet requirements or exposed finishes where suitable.
Ceiling	Exposed concrete soffit.
Lighting	Surface mounted lighting with motion sensor activation with variable time delay.
Power & Data	1 cleaner's socket.
Balustrade	Painted mild steel balustrades and handrails.

Lifts

Size	Minimum one 13 person passenger lift per building.
Finish	Stainless steel finishes internally with half height mirror at rear.
Flooring	Floor finishes to match ground floor lobby.
Lift Cover	Removable protective lift cover to be provided.

M&E

Intercom	All buildings should have an audio intercom systems.
Access Control	<input type="checkbox"/> All buildings should have a fob-entry system, with an over-ride facility for emergency access. <input type="checkbox"/> Fob access to include the all building entrances, bike stores and bins stores. Key access <input type="checkbox"/> Key access only required for plant rooms, risers and cleaners facilities.
Fire Detection	As required.
Emergency Lighting	As required.
CCTV	CCTV system to cover all entrance and exits to buildings and covered car storage areas. A provision for the future installation of CCTV to bins stores, bikes stores and entrance foyers should be considered where appropriate.

Signage

Entrance	Building directory is required in the entrance lobby that clearly indicates the different levels and apartment numbers.
Typical Upper Floor	Wayfinding signage is required on every floor. It should be adjacent to vertical circulation cores, i.e. lifts and staircases and clearly indicate the different levels and apartment numbers.
Statutory Signage	As required.

Joinery

Internal Doors	All doors are to be 44 mm thick solid core flush doors, with vision panels as required, selected timber veneer and with hardwood lipping all round. All doors to have three no. 100mm satin finished stainless steel ball bearing hinges and mortice lock.
Skirting Boards	100 x 19mm moisture resistant MDF square profile skirting.
Architrave	75 x 25mm moisture resistant MDF square profile architrave.
Window Boards	25mm moisture resistant MDF bull-nose profile window boards.

Ironmongery

General	All ironmongery - hinges, handles, roses, escutcheons, strike plates, thumb locks, door number, signage, door closers etc. to be matching brushed stainless steel. Ironmongery throughout should be robust and easily maintained. Replacement components should be readily available.
Locking	All magnetic locking devices should be designed to secure the full extent of the door leaf to the frame. Magnetic mortice locking systems are preferred over single point frame mounted magnets.
Door Handles & Push Plate	Selected brushed stainless steel pull handle and push plate
Door Stops	All doors to be fitted with wall mounted door stops
Door Closers	All door closers should be surface mounted brushed stainless steel.
Kick-plates	All doors to be fitted with brushed stainless steel kick-plates minimum 150mm high full width of door leaf.
Hold opens	Fire compartment doors should be held open by magnetic pads or 'hold-open' type door closures linked to the fire system.
Manifestation	As required.
Painting	
Walls & Ceilings	Two coats of vinyl matt emulsion in addition to a primer coat where required. Colour: Selected colour.
Joinery	Two coats of satinwood in addition to a primer coat. Colour: Selected colour.

Section Five Appendix

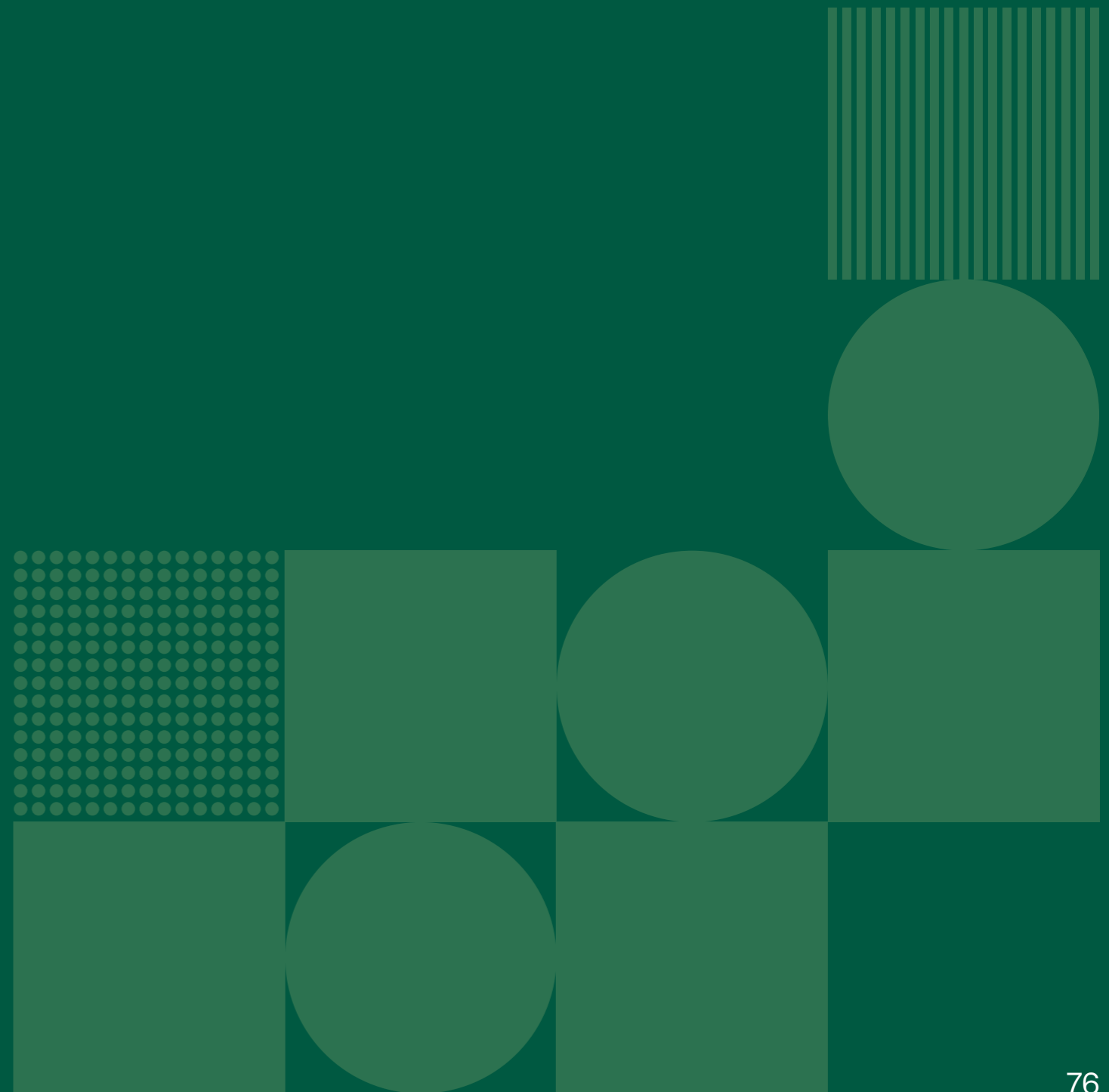

5.1

Universal Design Apartment Layouts

The following section includes a selection of Universal Design Home and Universal Design Home + apartment layouts that have been developed with the input of Centre for Excellence in Universal Design, at the National Disability Authority.

The following Universal Design Home apartments layouts are designed to be interchangeable with the 10% over apartment types. The approach to universal design homes should minimise variations. The percentage of Universal Design Home and Universal Design Home + apartments required will be set out Development Brief.

The following Universal Design Home + apartments layouts exceed the area the minimum area by more than 10%, however where possible the UD Home + layouts have been designed to be interchangeable with a standard LDA type. UD Home + apartments should be located on the ground floor where possible.

Apartment Type	10% Over	Open-Plan	Corridor	UDH	UDH+	Reference
1B2P	■	■		■		2B
1B2P		■			■	2C
2B3P	■		■	■		3B
2B3P			■		■	3C
2B4P	■		■	■		4C
2B4P			■		■	4D
3B5P	■		■	■		5B

UDH

UDH+

Studio

1B2P

2B3P

2B4P

3B5P

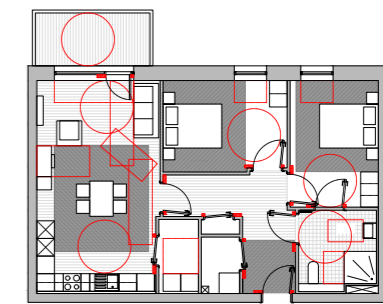
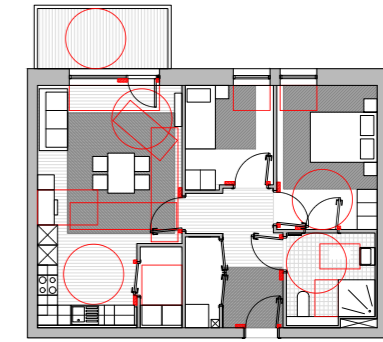
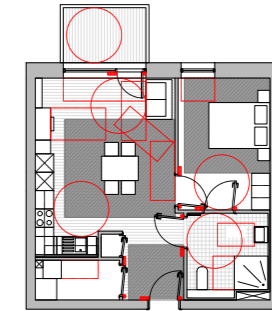
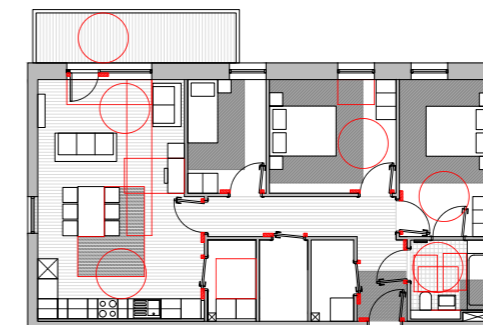
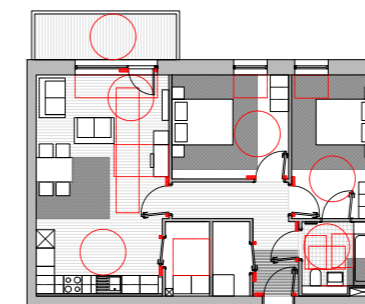
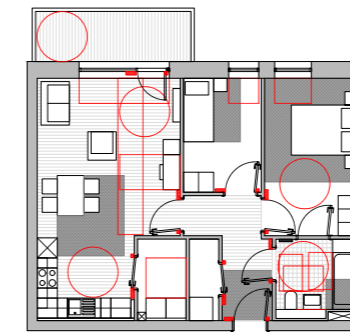
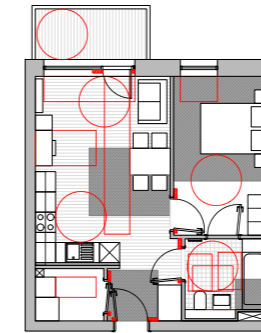

5.1.1 One Bedroom Two Person (UD Home)

Type 2B

	Provided	Minimum	10% Over	UDH
Living, Kitchen, Dining	26m ²	23m ²		
Double Bedroom (Main)	13.2m ²	13m ²		13m ²
Storage	3.3m ²	3m ²		
Apartment Area	50m²	45m²	49.5m²	
Balcony	5m ²	5m ²		5m ²

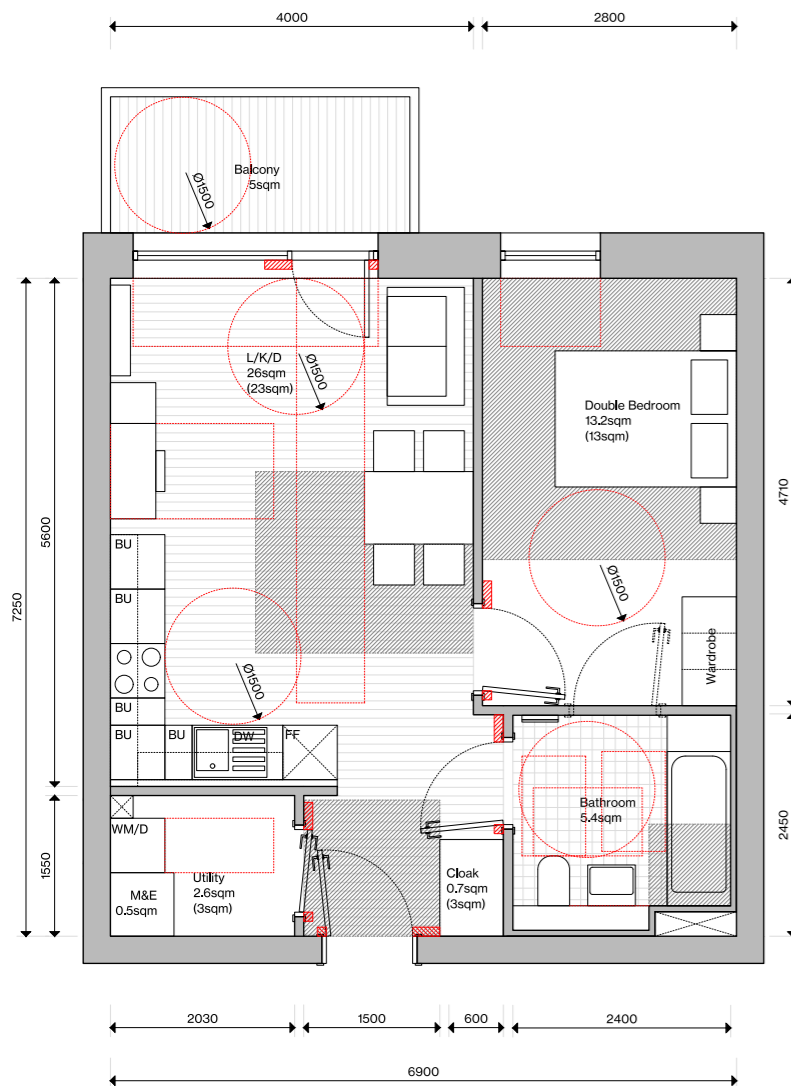

5.1.2 One Bedroom Two Person (UD Home +)

Type 2C

	Provided	Minimum	10% Over	UDH+
Living, Kitchen, Dining	29m ²	23m ²		
Double Bedroom (Main)	13m ²	13m ²		13m ²
Storage	3.4m ²	3m ²		
Apartment Area	55.6m²	45m²	49.5m²	
Balcony	5m ²	5m ²		5m ²

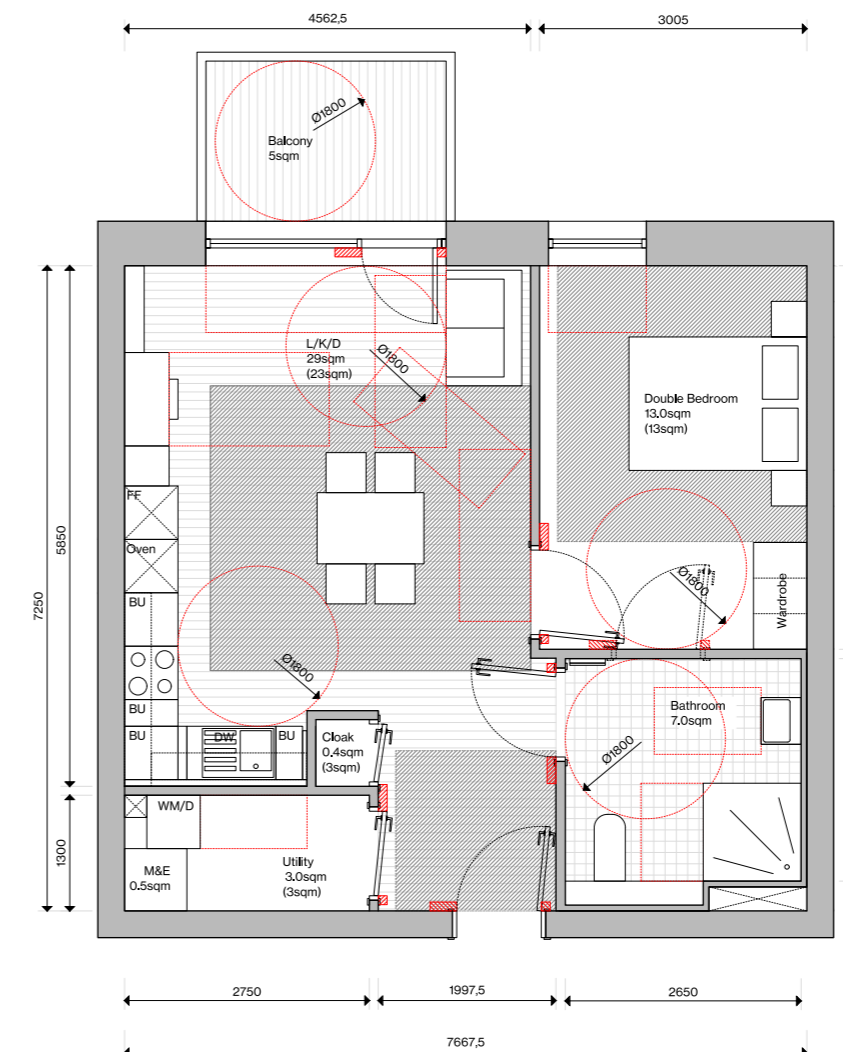

5.1.3 Two Bedroom Three Person (UD Home)

Type 3B

	Provided	Minimum	10% Over	UDH
Living, Kitchen, Dining	28m ²	28m ²		
Double Bedroom (Main)	13.2m ²	13m ²		13m ²
Single Bedroom	8m ²	7.1m ²		8m ²
Storage	5.2m ²	5m ²		
Apartment Area	69.6m²	63m²	69.3m²	
Balcony	7m ²	6m ²		7m ²

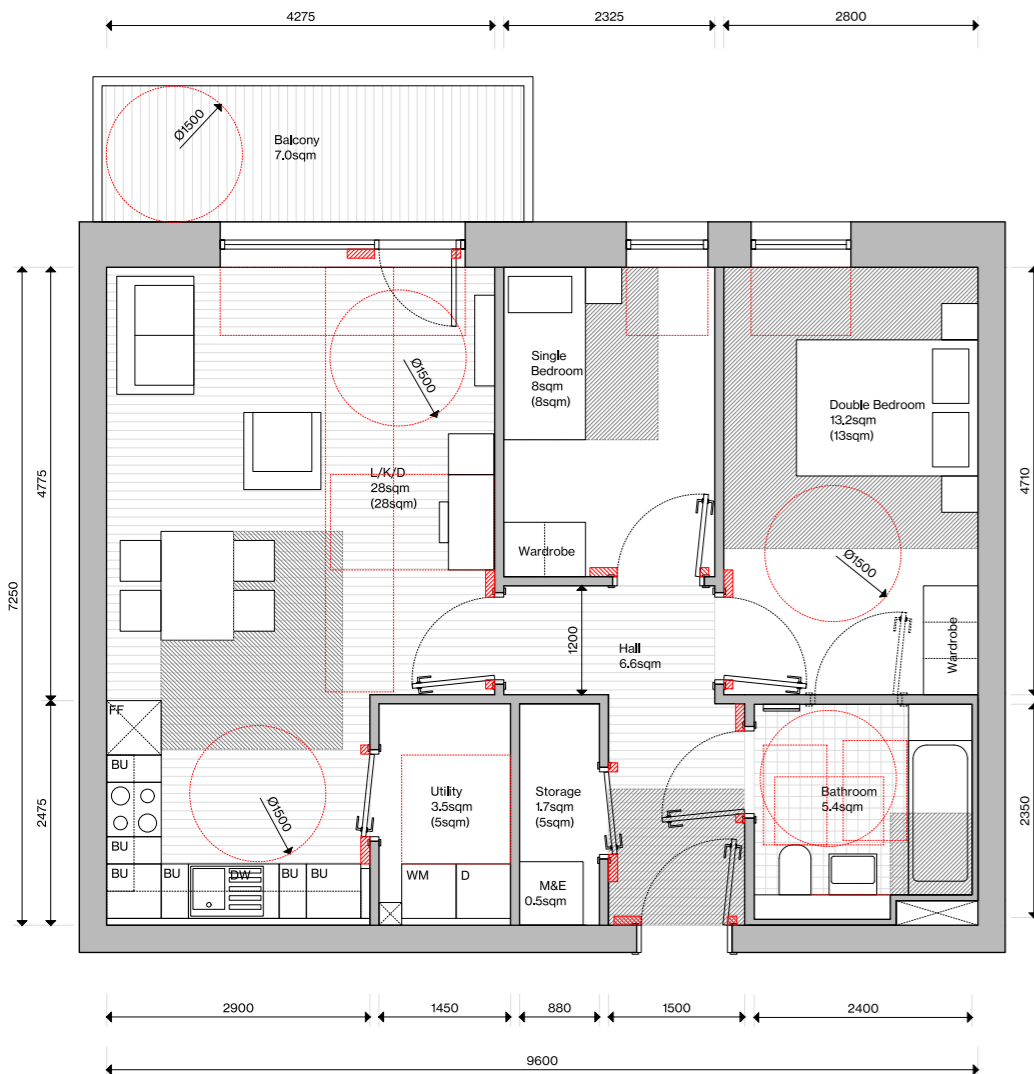

5.1.4 Two Bedroom Three Person (UD Home +)

Type 3C

	Provided	Minimum	10% Over	UDH+
Living, Kitchen, Dining	28m ²	28m ²		
Double Bedroom (Main)	13m ²	13m ²		13m ²
Single Bedroom	8m ²	7.1m ²		8m ²
Storage	5.2m ²	5m ²		
Apartment Area	73.68m²	63m²	69.3m²	
Balcony	7m ²	6m ²		7m ²

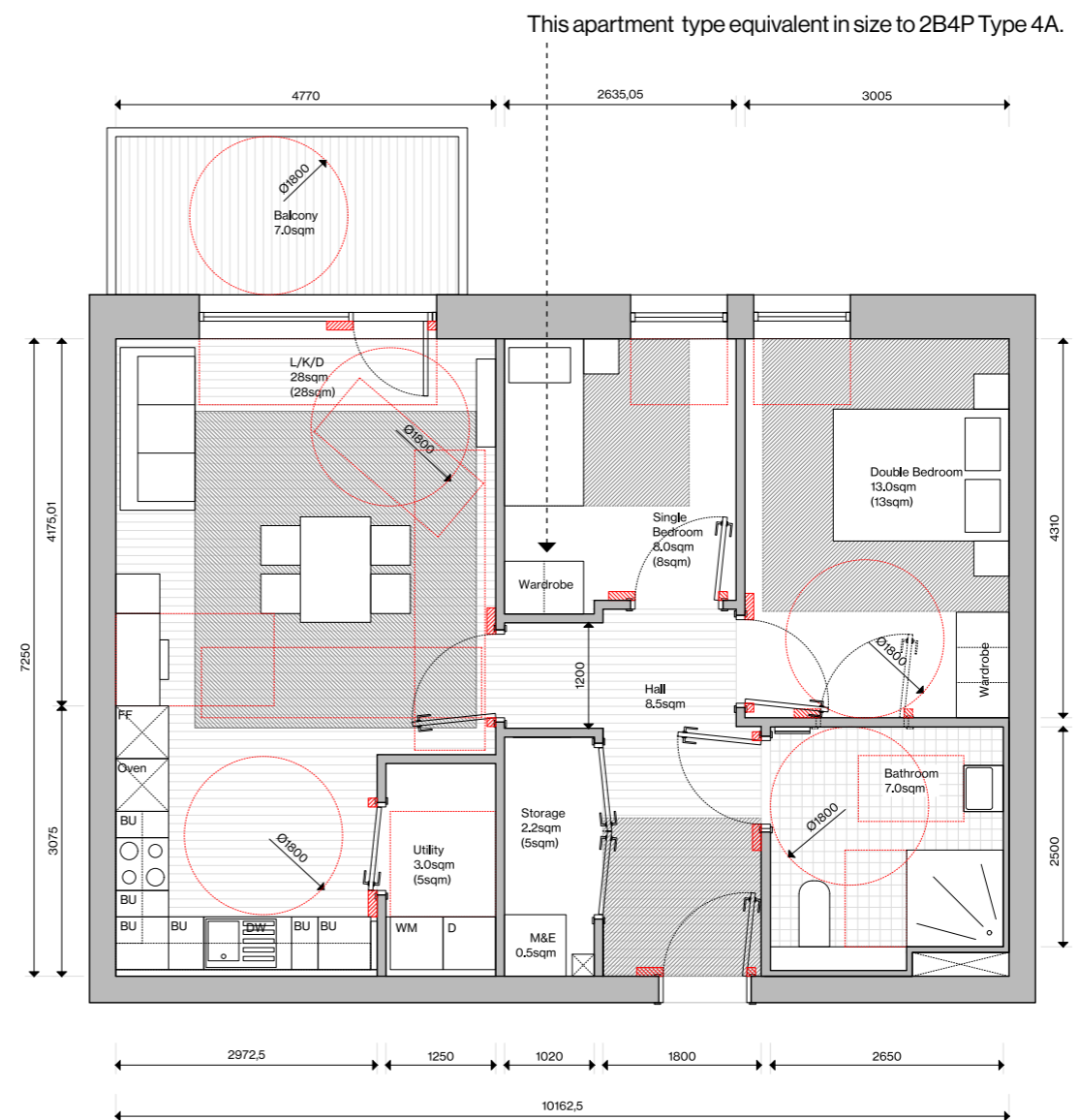

5.1.5 Two Bedroom Four Person (UD Home)

Type 4C

	Provided	Minimum	10% Over	UDH
Living, Kitchen, Dining	31m ²	30m ²		
Double Bedroom (Main)	13.2m ²	13m ²		13m ²
Double Bedroom	13m ²	11.4m ²		13m ²
Storage	6m ²	6m ²		
Apartment Area	81m²	73m²	80.3m²	
Balcony	7m ²	7m ²		7m ²

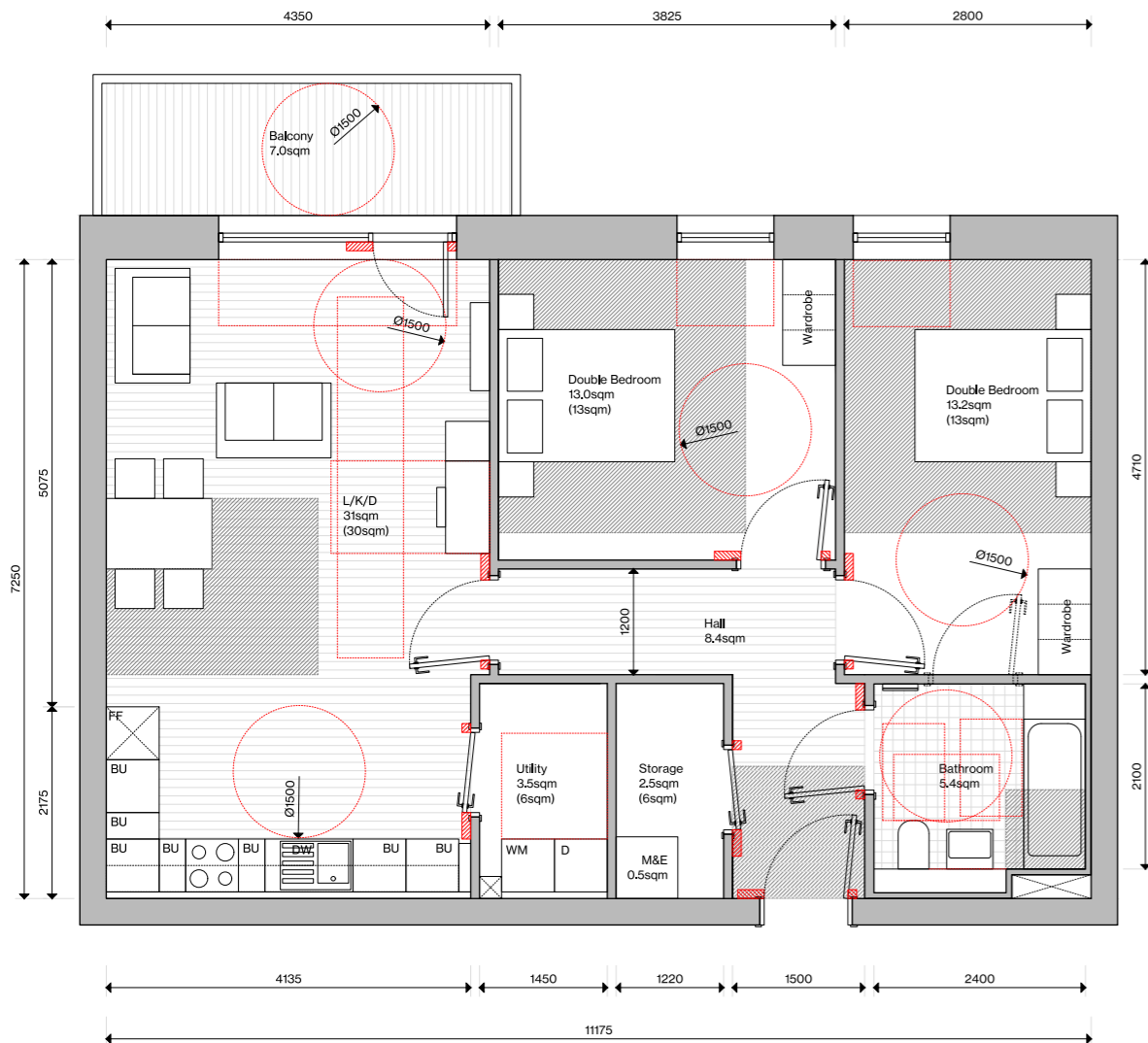

5.1.6 Two Bedroom Four Person (UD Home +)

Type 4D

	Provided	Minimum	10% Over	UDH+
Living, Kitchen, Dining, Bed-space	30.4m ²	30m ²		
Double Bedroom (Main)	13m ²	13m ²		13m ²
Double Bedroom	13m ²	11.4m ²		13m ²
Storage	6m ²	6m ²		
Apartment Area	84.3m²	73m²	80.3m²	
Balcony	7m ²	7m ²		7m ²



5.1.7 Three Bedroom Five Person (UD Home)

Type 5B

	Provided	Minimum	10% Over	UDH
Living, Kitchen, Dining	34.1m ²	34m ²		
Double Bedroom (Main)	13.2m ²	13m ²		13m ²
Double Bedroom	13m ²	13m ²		13m ²
Single Bedroom	8m ²	7.1m ²		8m ²
Storage	9.6m ²	9m ²		
Apartment Area	99m²	90m²	99m²	
Balcony	9m ²	9m ²		9m ²

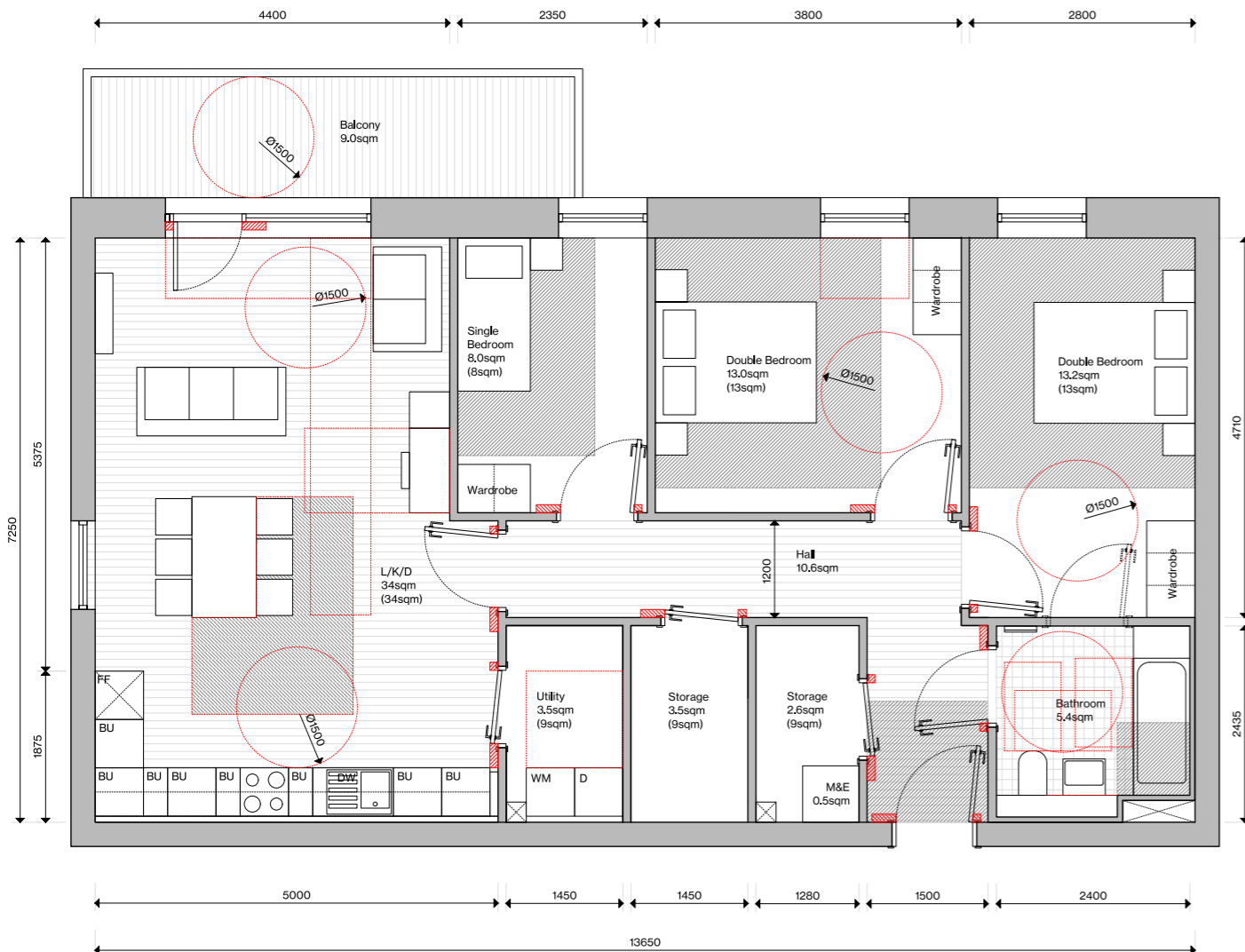

5.2

Non-sprinklered Apartment Layouts

The following section includes a selection of apartment layouts that meet the LDA minimum requirements and design principles set out within section 1.1 and 1.2 of this document. These apartment types are only for use on buildings without sprinklers. Refer to section 1.3 for 2B4P and 3B5P layouts.

Apartment Type	10% Over	Open-Plan	Corridor	Reference
1B2P	■		■	2D
2B3P	■		■	3D

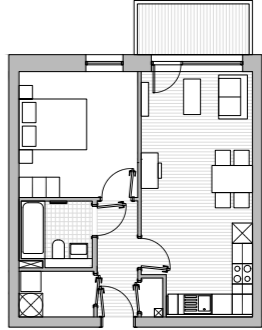
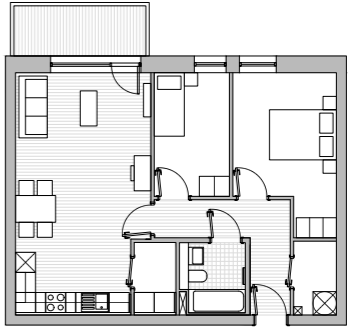
Open Plan	Corridor
Studio	
1B2P 10% Over	
2B3P 10% Over	
2B4P	
3B5P 10% Over	

5.2.1 One Bedroom Two Person (10% Over & Corridor)

Type 2D

	Provided	Minimum	10% Over
Living, Kitchen, Dining	23m ²	23m ²	
Double Bedroom (Main)	13.1m ²	11.4m ²	
Storage	5m ²	5m ²	
Apartment Area	50m²	45m²	49.5m²
Balcony	5m ²	5m ²	

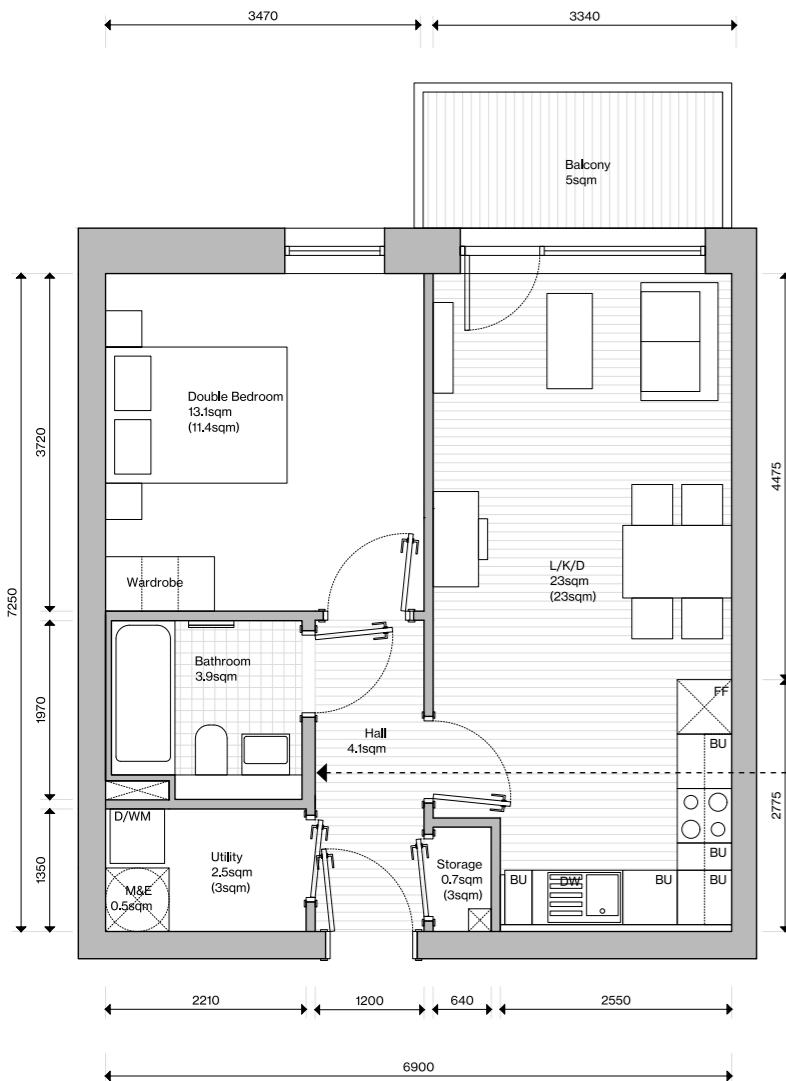

In apartments requiring internal fire compartmentalisation an increased wall thickness may be required between the bathroom pod and hallway.

5.2.2 Two Bedroom Three Person (Corridor)

Type 3D

	Provided	Minimum	10% Over
Living, Kitchen, Dining	28m ²	28m ²	
Double Bedroom (Main)	13.1m ²	13m ²	
Single Bedroom	8.3m ²	7.1m ²	
Storage	5m ²	5m ²	
Apartment Area	69.6m²	63m²	69.3m²
Balcony	m ²	6m ²	

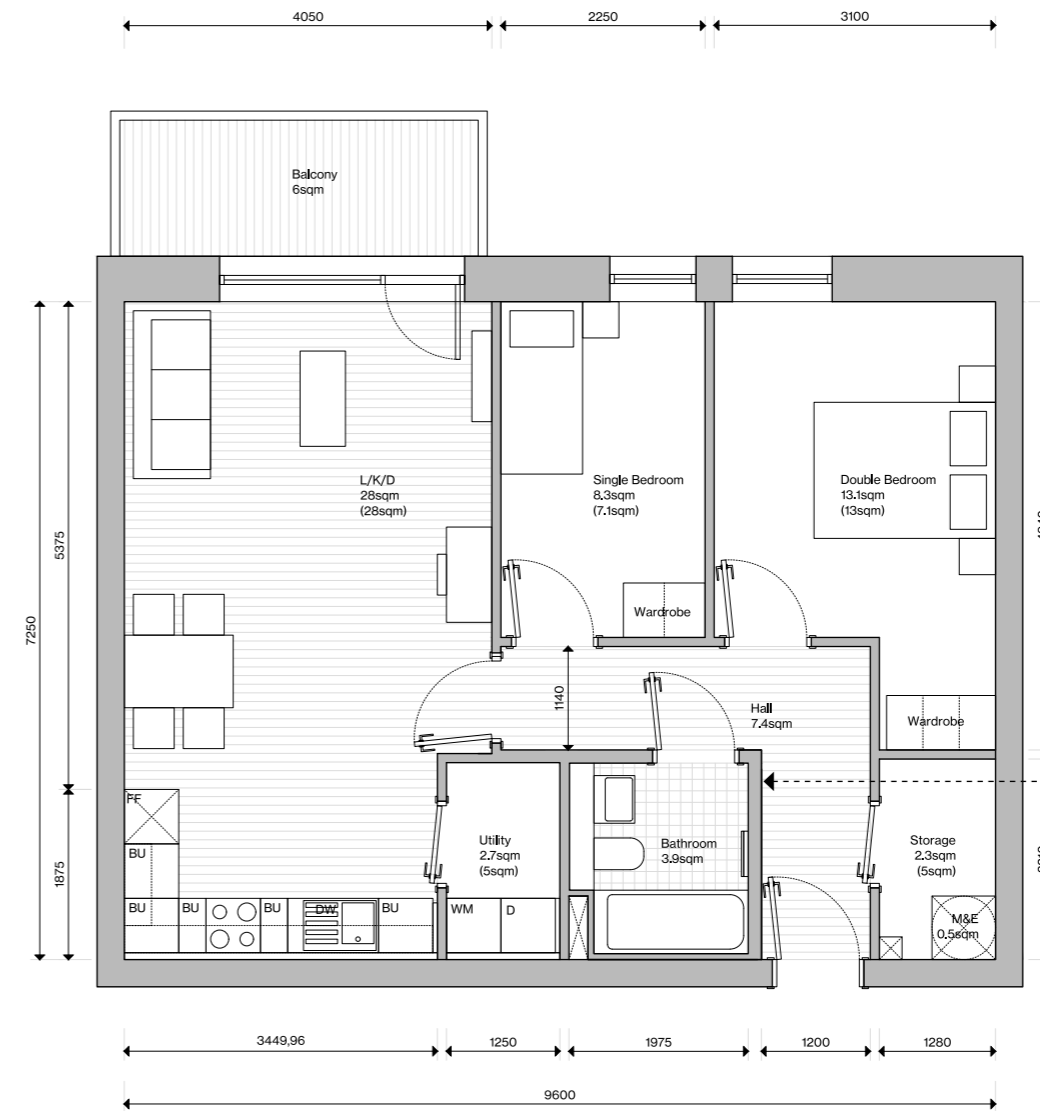

In apartments requiring internal fire compartmentalisation an increased wall thickness may be required between the bathroom pod and hallway.

